

M E L J A C ■

PRICE LIST IN EUROS (€)

2025

Validity 03/31/2026

Due to the current increase in raw materials, MELJAC reserves the right to modify, without notice, the period of validity of its prices. Please contact us.

www.meljac.com



CLASSIQUE

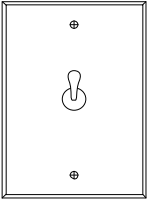

p. 2

ELLIPSE

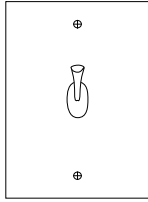

p. 19

DAMIER

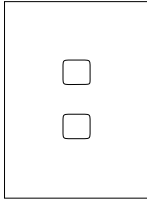

p. 26

CANNELÉE

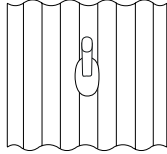

p. 28

SOLARIS



p. 31

TOURNAIRE

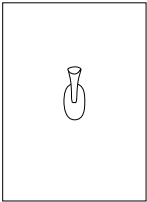

p. 35

STUDIO

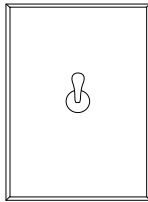

p. 37

SOL

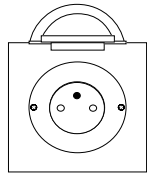

p. 39

VOLUMES

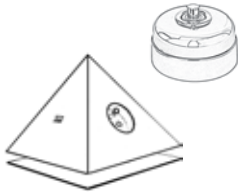

p. 42

PIERROT



p. 47

PLEXIGLASS



p. 49

LIMOGES

CLASSIQUE
ELLIPSE

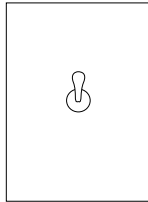

p. 51

CRESTRON CONNECTED

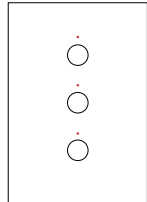

p. 55

SPOTS

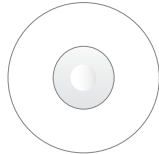

p. 57

TECHNICAL INFORMATION

Finishes
Options
p. 59

Mecanisms
Back boxes
Screwless system
p. 66

Characteristics of the collections

	Controls elements				Materials and thickness						Edges			Screws	
					Brass			Glass	Plexiglass	Porcelain					
	V&V	Inv auto	BP	BPE	3mm	5,5mm	6mm	4mm	3mm	3mm	Chamfer	Straight	Special	With screws	Screwless
Classique	✓	✓	✓	✓	✓						✓	UR	UR	✓	Option
Ellipse	✓	✓	✓		✓						UR	✓	UR	✓	Option
Damier			✓		✓						UR	✓	UR	UR	✓
Cannelée	✓	✓	✓			✓							✓		✓
Solaris	✓	✓	✓		✓								✓		✓
Tournaire	✓	✓	✓				✓						✓		✓
Studio	✓	✓	✓		✓						✓	UR			✓
Sol							✓					✓			✓
Pierrot	✓	✓	✓	✓				✓			✓			✓	
Plexiglass	✓	✓	✓	✓					✓		✓			✓	

UR : upon request

CLASSIQUE COLLECTION

SPECIFICATIONS

General

- Switches, reading lamps and sockets
- Protection index: IP20 (*IP21 on request*)
- Products must be installed indoors and earthed (*except for low current*)
- Cleaning only with a soft and dry duster, no product

Covering plate

- Solid brass 3mm thick
- With chamfer and visible screws
- **Screwless option available for some models – please contact us. Prices for backplates – p. 72**
- Finishes: Nickel, Chrome, Bronze médaille, Cuivre, Doré, Canon de fusil... (*p.59*)

Control mechanisms

- Round base - Droplet lever or push button
- Chrome-plated on cold and special finishes, golden on warm finishes
- Automatic connection by default, screw connection on request

SIZES & BACK BOXES

Sizes (in mm)	Recommended back boxes
Ø98 - 80x80 - 115x80 - 142x80 205x80 - 267x80	Mixed MELJAC, for dry partition and masonry
38x91 - 38x133 - 38x175	Narrow MELJAC, for masonry only
56x56 - Ø56	LEGRAND 89246, for masonry only
Oval - Hexagonal - Octagonal	LEGRAND 80051, for dry partition only

Renovation: can be adapted for other boxes: please contact us

How to fix?

The covering plate is directly screwed onto the back box.

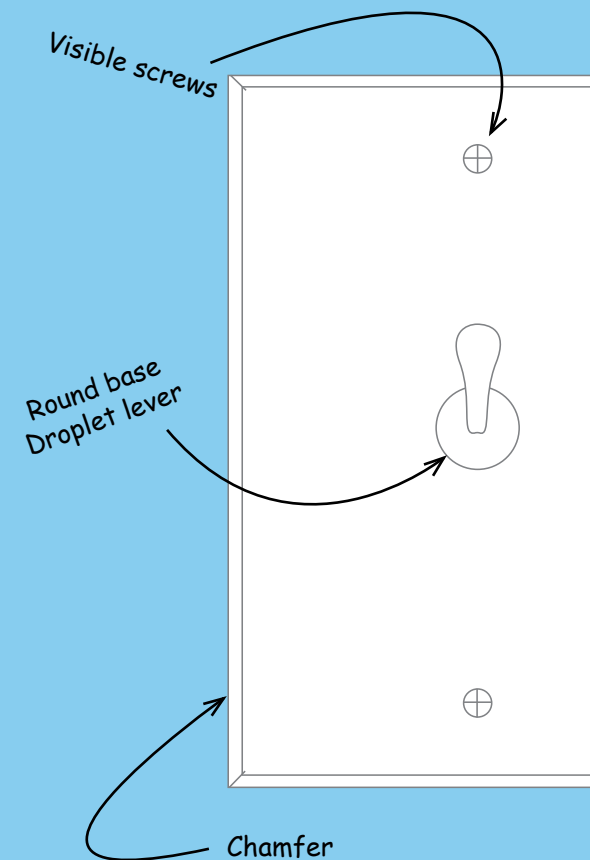

ORIGINE
FRANCE®
GARANTIE

BVCert. 6012053

CLASSIQUE

Diagrams	Back box colour	Size (mm)	Fittings	Reference	Cold finishes	Warm finishes	Special finishes	Shiny Gilding
	●	80x80x3	1 control element	FC3008A-A1100010	96,97	101,82	116,36	139,63
			2 control elements	FC3008A-A1100021	120,14	126,15	144,17	173,00
	●	80x80x3	1 Electronic Dimmer NU3514	FC3008A-K1000024	315,00	330,75	378,00	453,60
			1 Universal Dimmer S520519	FC3008A-K1000022	243,76	255,95	292,51	351,01
	●	80x80x3	Ambiant thermostat Legrand 76720	FC3008A-K1000120	} 561,75	589,84	674,10	808,92
			Ambiant thermostat Legrand 76720 with heat/cold selector	FC3008A-K1000124				
	●	80x80x3	Floor thermostat Schneider S520507	FC3008A-K1000126	455,68	478,46	546,82	656,18
			Thermostat Schneider S520509	FC3008A-K1000127	482,31	506,43	578,77	694,52

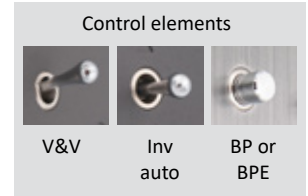

Control elements examples with options

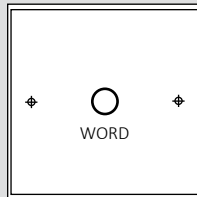

Fittings	Reference	Price from
1 BP	FC3008A-A1100010	96,97
Engraving 1 word	FZ9999Z-ZGR0001M99	+ 10,50

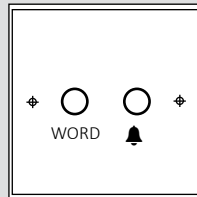

Fittings	Reference	Price from
2 BP	FC3008A-A1100021	120,14
Engraving 1 word	FZ9999Z-ZGR0001M99	+ 10,50
Engraving 1 symbol	FZ9999Z-ZGR1001S99	+ 10,50

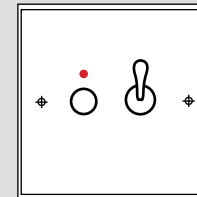

Fittings	Reference	Price from
1 BP + 1 V&V	FC3008A-A1100021	120,14
1 LED indicator	FZLED1Z-Z00D301299	+ 17,10



80x80x3

Discreet light marking 2700k-warm
Discreet light marking 4000k-cold

FC3008C-K1002260
FC3008C-K1002261

215,84







226,63

259,01

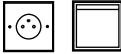
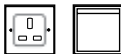
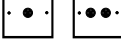
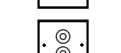
310,81

Prices 04/25 in euros
without VAT

CLASSIQUE

Diagrams	Back box colour	Size (mm)	Fittings	Reference	Cold finishes	Warm finishes	Special finishes	Shiny Gilding
	●	80x80x3	Blank	FC3008A-B0000000	73,79	77,48	88,55	106,26
	●	80x80x3	1 PC 2x10/16A+T	FC3008A-B0000010	99,54	104,52	119,45	143,34
			1 PC + Cover	FC3008A-F0000010	212,17	222,78	254,60	305,52
	●	80x80x3	1 universal PC Wonpro	FC3008A-W5000010	110,24	115,75	132,29	158,75
			1 universal PC Wonpro + Cover	FC3008A-F5000010	222,87	234,01	267,44	320,93
	●	80x80x3	1 DIN base	FC3008A-B0001621	93,60	98,28	112,32	134,78
			2 DIN bases	FC3008A-B0001631	113,40	119,07	136,08	163,30
	●	80x80x3	1 Speaker	FC3008A-B0001540	109,40	114,87	131,28	157,54
	●	80x80x3	2 Flush RCA sockets	FC3008A-B0001870	154,15	161,86	184,98	221,98
	●	80x80x3	1 TV outlet	FC3008A-B0001700	84,23	88,44	101,08	121,30
			2 TV outlets	FC3008A-B0001710	94,67	99,40	113,60	136,32
	●	80x80x3	1 TV-FM-SAT	FC3008A-B0000570	141,80	148,89	170,16	204,19
	●	80x80x3	1 HDMI	FC3008A-B0001460	118,11	124,02	141,73	170,08
			2 HDMI	FC3008A-B0001470	162,42	170,54	194,90	233,88
	●	80x80x3	1 RJ45	FC3008A-B0000730	114,05	119,75	136,86	164,23
			2 RJ45	FC3008A-B0000740	154,30	162,02	185,16	222,19











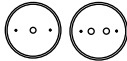



Prices 04/25 in euros
without VAT

CLASSIQUE

Diagrams	Back box colour	Size (mm)	Fittings	Reference	Cold finishes	Warm finishes	Special finishes	Shiny Gilding
	●	80x80x3	1 A USB power - 7,5W 1 C USB power - 20W	FC3008A-B0001211	179,26	188,22	215,11	258,13
	●	80x80x3	1 C USB power - 45W (gravure optionnelle) 1 C USB power - 65W (gravé)	FC3008A-B0001216 FC3008A-B0001214	208,36 269,90	218,78 283,40	250,03 323,88	300,04 388,66
	●	80x80x3	1 double AA USB power - 15W 1 double AC USB power - 17,5W	FC3008A-B0001221	186,44	195,76	223,73	268,48
	●	80x80x3	1 double CC USB power - 30W	FC3008A-B0001223	214,16	224,87	256,99	308,39
	●	80x80x3	1 A or C USB F/F adaptator 2 AA, CC ou AC USB F/F adaptators	FC3008A-B0001210 FC3008A-B0001220	116,73 159,66	122,57 167,64	140,08 191,59	168,10 229,91
	●	80x80x3	1 Cable outlet 1 Cable lead-out 1 Brush cable lead-out	FC3008A-B0001290 FC3008A-B0001370 FC3008A-B0001292	81,03 178,29 105,99	85,08 187,20 111,29	97,24 213,95 127,19	116,69 256,74 152,63

Prices 04/25 in euros
without VAT

















CLASSIQUE

Diagrams	Back box colour	Size (mm)	Fittings	Reference	Cold finishes	Warm finishes	Special finishes	Shiny Gilding
		Ø98x3	1 control element	FC3009A-A1100010	129,74	136,23	155,69	186,83
			2 control elements	FC3009A-A1100021	152,92	160,57	183,50	220,20
		Ø98x3	Blank	FC3009A-B0000000	106,56	111,89	127,87	153,44
		Ø98x3	1 PC 2x10/16A+T	FC3009A-B0000010	132,31	138,93	158,77	190,52
		Ø98x3	1 DIN base	FC3009A-B0001621	126,37	132,69	151,64	181,97
			2 DIN bases	FC3009A-B0001631	146,17	153,48	175,40	210,48
		Ø98x3	1 Speaker	FC3009A-B0001540	142,17	149,28	170,60	204,72
		Ø98x3	2 Flush RCA sockets	FC3009A-B0001870	186,93	196,28	224,32	269,18
		Ø98x3	1 TV outlet	FC3009A-B0001700	117,00	122,85	140,40	168,48
			2 TV outlets	FC3009A-B0001710	127,44	133,81	152,93	183,52
		Ø98x3	1 TV-FM-SAT	FC3009A-B0000570	174,59	183,32	209,51	251,41
		Ø98x3	1 HDMI	FC3009A-B0001460	150,89	158,43	181,07	217,28
		Ø98x3	1 RJ45	FC3009A-B0000730	146,82	154,16	176,18	211,42
2 RJ45			FC3009A-B0000740	187,07	196,42	224,48	269,38	
	Ø98x3	1 A USB power 1 C USB power- 20W	FC3009A-B0001211	212,04	222,64	254,44	305,33	
	Ø98x3	1 Cable outlet	FC3009A-B0001290	113,80	119,49	136,56	163,87	
1 Cable lead-out		FC3009A-B0001370	211,07	221,62	253,28	303,94		

Other USB models on page 5
Price on request

Prices 04/25 in euros
without VAT

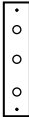

CLASSIQUE

Diagrams	Back box colour	Size (mm)	Fittings	Reference	Cold finishes	Warm finishes	Special finishes	Shiny Gilding
		56x56x3	1 V&V or 1 BP *	FC3013A-A1100010	89,90	94,40	107,88	129,46
		∅56x3	1 V&V or 1 BP *	FC3014A-A1100010	104,40	109,62	125,28	150,34
		Hexagonal shape	1 control element	FC3015A-A1100010	125,96	132,26	151,15	181,38
		Octagonal shape	1 control element	FC3016A-A1100010	125,96	132,26	151,15	181,38
		Oval shape	1 control element	FC3017A-A1100010	125,96	132,26	151,15	181,38
		38x91x3	1 control element	FC3011A-A1100010	96,97	101,82	116,36	139,63
		38x133x3	1 control element 2 control elements	FC3010A-A1100010 FC3010A-A1100020	105,06 128,25	110,31 134,66	126,07 153,90	151,28 184,68
		38x175x3	3 control elements	FC3012A-A1100030	172,98	181,63	207,58	249,10

*V&V : 600 series
BP : 1200 series

Prices 04/25 in euros
without VAT

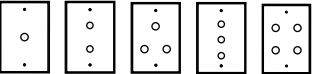
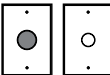
CLASSIQUE

Diagrams	Back box colour	Size (mm)	Fittings	Reference	Cold finishes	Warm finishes	Special finishes	Shiny Gilding
	●	80x115x3	1 control element	FC3001A-A1100010	105,06	110,31	126,07	151,28
			2 control elements	FC3001A-A1100020	128,25	134,66	153,90	184,68
			3 control elements in triangle	FC3001A-A1100031	151,42	158,99	181,70	218,04
			3 BP or 3 BPE in line	FC3001A-A1100090	151,42	158,99	181,70	218,04
			4 control elements	FC3001A-A1100040	174,60	183,33	209,52	251,42
	●	80x115x3	1 Electronic Dimmer NU3514	FC3001A-K1000023	323,11	339,27	387,73	465,28
			1 Universal Dimmer S520519	FC3001A-K1000022	253,10	265,76	303,72	364,46
	●	80x115x3	1 Motion detector Leg. 67026	FC3001A-K1000135	362,00	380,10	434,40	521,28

Prices 04/25 in euros
without VAT

Control elements examples with options

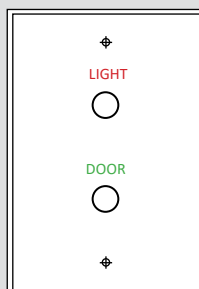



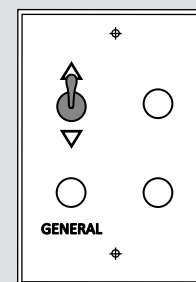



Fittings	Reference	Prices from
2 BP	FC3001A-A1100020	128,25
Light engraving	FZ9999Z-ZGLU000199	+63,00
Additional light engraving	FZ9999Z-ZGLU100199	+63,00

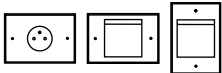

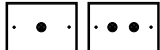
Fittings	Reference	Prices from
1 Inv auto + 3 BP	FC3001A-A1100040	174,60
Engraving 2 triangles	FZ9999Z-ZGR0002T99	+ 21,00
Engraving 1 word	FZ9999Z-ZGR1001M99	+ 10,50
Resin engraving 1 word	FZ9999Z-ZR00001M99	+ 16,80

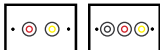
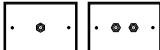
CLASSIQUE

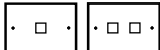
Diagrams	Back box colour	Size (mm)	Fittings	Reference	Cold finishes	Warm finishes	Special finishes	Shiny Gilding
	●	115x80x3	Blank	FC3000A-B0000000	81,89	85,98	98,27	117,92
	●	115x80x3	1 PC 2x10/16A+T	FC3000A-B0000010	107,64	113,02	129,17	155,00
	●	115x80x3	1 PC + Cover (horizontal)	FC3000A-F0000010	} 220,28	} 231,29	} 264,34	} 317,21
	●	80x115x3	1 PC + Cover (vertical)	FC3001A-F0000010				
	●	115x80x3	1 universal PC Wonpro	FC3000A-W5000010	118,34	124,26	142,01	170,41
	●	115x80x3	1 DIN base	FC3000A-B0001621	101,70	106,79	122,04	146,45
			2 DIN bases	FC3000A-B0001631	121,50	127,58	145,80	174,96
	●	115x80x3	1 Speaker	FC3000A-B0001540	117,50	123,38	141,00	169,20
	●	115x80x3	2 Flush RCA sockets	FC3000A-B0001870	162,25	170,36	194,70	233,64
			3 Flush RCA sockets	FC3000A-B0001880	202,42	212,54	242,90	291,48
	●	115x80x3	1 TV outlet	FC3000A-B0001700	92,33	96,95	110,80	132,96
			2 TV outlets	FC3000A-B0001710	102,75	107,89	123,30	147,96
	●	115x80x3	1 TV-FM-SAT	FC3000A-B0000570	149,91	157,41	179,89	215,87
	●	115x80x3	1 HDMI	FC3000A-B0001460	126,20	132,51	151,44	181,73
	●	115x80x3	1 RJ45	FC3000A-B0000730	122,14	128,25	146,57	175,88
			2 RJ45	FC3000A-B0000740	162,39	170,51	194,87	233,84

Plinth size possible
115x63x3
Contact us

Prices 04/25 in euros
without VAT

CLASSIQUE

Diagrams	Back box colour	Size (mm)	Fittings	Reference	Cold finishes	Warm finishes	Special finishes	Shiny Gilding
	●	115x80x3	1 A USB power - 7,5W 1 C USB power - 20W	FC3000A-B0001211	187,36	196,72	224,83	269,79
	●	115x80x3	1 C USB power - 45W (optional engraving) 1 C USB power - 65W (engraved)	FC3000A-B0001216 FC3000A-B0001214	216,46 278,00	227,28 291,90	259,75 333,60	311,70 400,32
	●	115x80x3	1 double AA USB power - 15W 1 double AC USB power - 17,5W	FC3000A-B0001221	194,54	204,27	233,45	280,14
	●	115x80x3	1 double CC USB power - 30W	FC3000A-B0001223	222,25	233,36	266,70	320,04
	●	115x80x3	1 A or C USB F/M adaptor	FC3008A-B0001210	122,17	128,28	146,60	175,92
	●	115x80x3	2 USB F/M adaptators	FC3008A-B0001220	162,45	170,57	194,94	233,92
Special plates	Back box colour	Size (mm)	Fittings	Reference	Cold finishes	Warm finishes	Special finishes	Shiny Gilding
	●	115x80x3	1 Cable outlet 1 Cable lead-out	FC3000A-B0001290 FC3000A-B0001370	89,11 186,40	93,57 195,72	106,93 223,68	128,32 268,42
	●	115x80x3	Vimar Shaver socket	FC3000A-B1001300	353,82	371,51	424,58	509,50
	●	80x115x3	HAGER key card switch	FC3001A-K1000180	425,55	446,83	510,66	612,79

Prices 04/25 in euros
without VAT

CLASSIQUE

Tulipe reading lamps		Back box colour	Size (mm)	Fittings	Reference	Cold finishes	Warm finishes	Special finishes	Shiny Gilding
	●	80x115x3	bend 0°	FC3001A-M1000020	402,85	422,99	483,42	580,10	
			bend 135°	FC3001A-M1000010					
	●	80x115x3	bend 0° + 1 control element	FC3001A-M1000080	426,03	447,33	511,24	613,49	
			bend 135° + 1 control element	FC3001A-M1000070					
	○	38x133x3	bend 0° + 1 control element	FC3010A-M1000080	426,03	447,33	511,24	613,49	
			bend 135° + 1 control element	FC3010A-M1000070					
	●	80x115x3	bend 0° + 2 control elements	FC3001A-M1000380	449,20	471,66	539,04	646,85	
			bend 135° + 2 control elements	FC3001A-M1000370					
	●	80x115x3	bend 0°	FC3001A-M1000050	402,85	422,99	483,42	580,10	
			bend 135°	FC3001A-M1000040					
	●	80x115x3	bend 0° + 1 control element	FC3001A-M1000110	426,03	447,33	511,24	613,49	
			bend 135° + 1 control element	FC3001A-M1000100					
	○	38x133x3	bend 0° + 1 control element	FC3010A-M1000110	426,03	447,33	511,24	613,49	
			bend 135° + 1 control element	FC3010A-M1000100					
	●	80x115x3	bend 0° + 2 control elements	FC3001A-M1000410	449,20	471,66	539,04	646,85	
			bend 135° + 2 control elements	FC3001A-M1000400					

Please see technical details
from page 66

Tulipe straight cone







Tulipe beveled cone



Prices 04/25 in euros
without VAT

CLASSIQUE

Roseau reading lamps	Back box colour	Size (mm)	Fittings	Reference	Cold finishes	Warm finishes	Special finishes	Shiny Gilding
 	●	80x115x3	bend 0°	FC3001A-M2000020	341,79	358,88	410,15	492,18
			bend 135°	FC3001A-M2000010				
	●	80x115x3	bend 0° + 1 control element	FC3001A-M2000080	364,96	383,21	437,95	525,54
			bend 135° + 1 control element	FC3001A-M2000070				
 	○	38x133x3	bend 0° + 1 control element	FC3010A-M2000080	364,96	383,21	437,95	525,54
			bend 135° + 1 control element	FC3010A-M2000070				
	●	80x115x3	bend 0° + 2 control elements	FC3001A-M2000380	388,14	407,55	465,77	558,92
			bend 135° + 2 control elements	FC3001A-M2000370				

Roseau

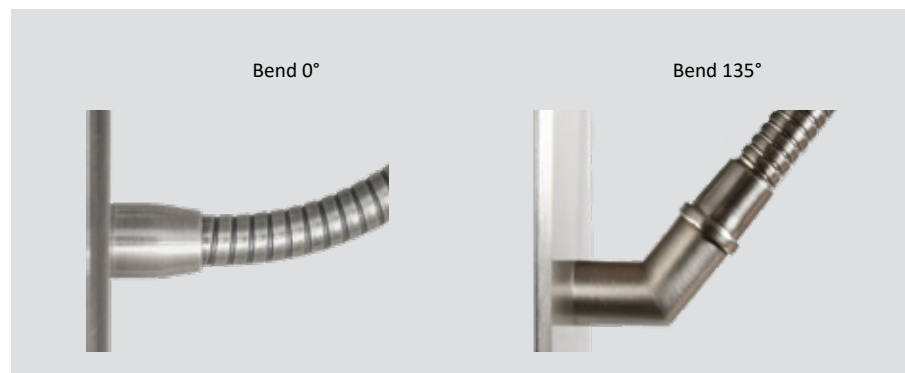







Prices 04/25 in euros
without VAT

CLASSIQUE

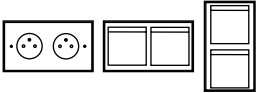
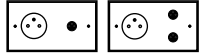
Diagrams	Back box colour	Size (mm)	Fittings	Reference	Cold finishes	Warm finishes	Special finishes	Shiny Gilding
	●	80x142x3	1 control element	FC3003A-A1100010	126,62	132,95	151,94	182,33
			2 control elements	FC3003A-A1100020	149,80	157,29	179,76	215,71
			3 control elements	FC3003A-A1100030	172,98	181,63	207,58	249,10
			4 control elements	FC3003A-A1100040	196,14	205,95	235,37	282,44
			5 control elements	FC3003A-A1100050	219,32	230,29	263,18	315,82
			6 control elements	FC3003A-A1100060	242,50	254,63	291,00	349,20
	●	80x142x3	1 PC + 1 control element	FC3003A-C0010010	152,37	159,99	182,84	219,41
			1 PC + 2 control elements	FC3003A-C0010020	175,54	184,32	210,65	252,78
	●	80x142x3	1 Var E + 1 control element	FC3003A-K1000313	367,83	386,22	441,40	529,68
			1 Var E + 2 control elements	FC3003A-K1000333	391,00	410,55	469,20	563,04
	●	142x80x3	1 PC + 1 control element	FC3002A-C0010010	152,37	159,99	182,84	219,41
			1 PC + 2 control elements	FC3002A-C0010020	175,54	184,32	210,65	252,78
	●	142x80x3	1 Var E + 1 control element	FC3002A-K1000313	367,83	386,22	441,40	529,68
			1 Var E + 2 control elements	FC3002A-K1000333	391,00	410,55	469,20	563,04

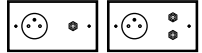
Prices 04/25 in euros
without VAT

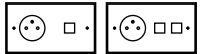
CLASSIQUE

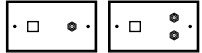
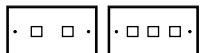
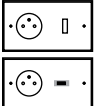

Diagrams	Back box colour	Size (mm)	Fittings	Reference	Cold finishes	Warm finishes	Special finishes	Shiny Gilding
	●	142x80x3	Blank	FC3002A-B0000000	103,45	108,62	124,14	148,97
	●	142x80x3	2 PC 2x10/16A+T	FC3002A-B0000020	154,94	162,69	185,93	223,12
	●	142x80x3	2 PC + Covers (horizontal)	FC3002A-F0000020	} 380,22	} 399,23	} 456,26	} 547,51
	●	80x142x3	2 PC + Covers (vertical)	FC3003A-F0000020				
	●	142x80x3	1 PC + 1 DIN base	FC3002A-B0052640	149,00	156,45	178,80	214,56
	●	142x80x3	1 PC + 2 DIN bases	FC3002A-B0052710	168,80	177,24	202,56	243,07
	●	142x80x3	1 PC + 1 Speaker	FC3002A-B0047320	164,80	173,04	197,76	237,31
	●	142x80x3	1 PC + 1 TV outlet	FC3002A-B0058240	139,62	146,60	167,54	201,05
	●	142x80x3	1 PC + 2 TV outlets	FC3002A-B0058310	150,06	157,56	180,07	216,08
	●	142x80x3	1 PC + 1 TV-FM-SAT	FC3002A-B0007340	197,20	207,06	236,64	283,97
	●	142x80x3	1 PC + 1 RJ45	FC3002A-B0010640	169,44	177,91	203,33	244,00
	●	142x80x3	1 PC + 2 RJ45	FC3002A-B0010710	209,69	220,17	251,63	301,96
	●	142x80x3	1 RJ45 + 1 TV-FM-SAT	FC3002A-B0012600	211,72	222,31	254,06	304,87
	●	142x80x3	1 RJ45 + 1 TV outlet	FC3002A-B0060760	154,13	161,84	184,96	221,95
	●	142x80x3	1 RJ45 + 2 TV outlets	FC3002A-B0060830	164,57	172,80	197,48	236,98
	●	142x80x3	2 RJ45	FC3002A-B0000740	183,95	193,15	220,74	264,89
	●	142x80x3	3 RJ45	FC3002A-B0000750	224,20	235,41	269,04	322,85
	●	142x80x3	1 PC + 1 A USB power	FC3002A-B0028841	234,65	246,38	281,58	337,90
	●	142x80x3	1 PC + 1 C USB power- 20W					

Plinth size possible
142x63x3
Contact us

Other USB models on page 5
Price on request

Prices 04/25 in euros
without VAT

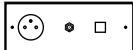
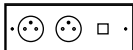
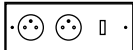
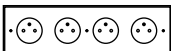
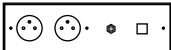
CLASSIQUE

Diagrams	Back box colour	Size (mm)	Fittings	Reference	Cold finishes	Warm finishes	Special finishes	Shiny Gilding
	●	205x80x3	Blank	FC3004A-B0000000	168,80	177,24	202,56	243,07
	●	205x80x3	3 PC 2x10/16A+T	FC3004A-B0000030	246,04	258,34	295,25	354,30
	●	205x80x3	2 PC + 1 TV outlet	FC3004A-B0058250	230,72	242,26	276,86	332,23
	●	205x80x3	2 PC + 2 TV outlets	FC3004A-B0058320	241,15	253,21	289,38	347,26
	●	205x80x3	2 PC + 1 TV-FM-SAT	FC3004A-B0007350	288,31	302,73	345,97	415,16
	●	205x80x3	1 PC + 1 TV outlet + 1 RJ45	FC3004A-B1631560	245,23	257,49	294,28	353,14
	●	205x80x3	1 PC + 2 TV outlets + 1 RJ45	FC3004A-B1631770	255,65	268,43	306,78	368,14
	●	205x80x3	1 PC + 1 TV-FM-SAT + 1 RJ45	FC3004A-B1051950	302,81	317,95	363,37	436,04
	●	205x80x3	2 PC + 1 RJ45	FC3004A-B0010650	260,54	273,57	312,65	375,18
	●	205x80x3	2 PC + 2 RJ45	FC3004A-B0010720	300,79	315,83	360,95	433,14
	●	205x80x3	1 PC + 1 USB + 1 RJ45	FC3004A-B1074640	340,25	357,26	408,30	489,96
	●	205x80x3	2 PC + 1 Type A USB power	FC3004A-B0028851	325,75	342,04	390,90	469,08
	●	205x80x3	2 PC + 1 Type C USB power					
	●	267x80x3	Blank	FC3006A-B0000000	211,43	222,00	253,72	304,46
	●	267x80x3	4 PC 2x10/16A+T	FC3006A-B0000040	314,41	330,13	377,29	452,75
	●	267x80x3	3 PC + 1 TV outlet	FC3006A-B0058260	299,10	314,06	358,92	430,70
	●	267x80x3	3 PC + 2 TV outlets	FC3006A-B0058330	309,54	325,02	371,45	445,74
	●	267x80x3	3 PC + 1 TV-FM-SAT	FC3006A-B0007360	356,70	374,54	428,04	513,65
	●	267x80x3	2 PC + 1 TV outlet + 1 RJ45	FC3006A-B1631571	313,61	329,29	376,33	451,60
	●	267x80x3	2 PC + 2 TV outlets + 1 RJ45	FC3006A-B1631781	324,04	340,24	388,85	466,62
	●	267x80x3	2 PC + 2 RJ45	FC3006A-B0010720	343,42	360,59	412,10	494,52
	●	267x80x3	3 PC + 1 RJ45	FC3006A-B0010660	328,92	345,37	394,70	473,64
	●	267x80x3	3 PC + 2 RJ45	FC3006A-B0010730	369,17	387,63	443,00	531,60

Other USB models on page 5
Price on request

Prices 04/25 in euros
without VAT

CLASSIQUE - EXPORT STANDARD SOCKETS

Diagrams	Back box colour	Size (mm)	Fittings	Reference	Cold finishes	Warm finishes	Special finishes	Shiny Gilding
	●	115x80x3	1 PC Schuko	FC3000A-B0000250	115,08	120,83	138,10	165,72
		115x80x3	1 PC Schuko + Cover (horizontal)	FC3000A-F0000250	} 227,71	239,10	273,25	327,90
		80x115x3	1 PC Schuko + Cover (vertical)	FC3001A-F0000250				
	●	115x80x3	1 PC Unel (Schuko + Bipasso)	FC3000A-B0000490	148,88	156,32	178,66	214,39
			1 PC Unel + 1 PC Bipasso	FC3000A-B0084980	195,78	205,57	234,94	281,93
	●	115x80x3	1 PC Bipasso	FC3000A-B0000410	128,80	135,24	154,56	185,47
			2 PC Bipasso	FC3000A-B0000420	175,71	184,50	210,85	253,02
			3 PC Bipasso	FC3000A-B0000430	222,61	233,74	267,13	320,56
	●	80x80x3	1 PC Schuko	FC3008A-B0000250	106,98	112,33	128,38	154,06
			1 PC Schuko + Cover	FC3008A-F0000250	219,62	230,60	263,54	316,25
	●	80x80x3	1 PC Unel (Schuko + Bipasso)	FC3008A-B0000490	140,78	147,82	168,94	202,73
	●	80x80x3	1 PC Bipasso	FC3008A-B0000410	120,70	126,74	144,84	173,81
			2 PC Bipasso	FC3008A-B0000420	167,61	175,99	201,13	241,36
	●	Ø98x3	1 PC Schuko	FC3009A-B0000250	139,76	146,75	167,71	201,25
	●	Ø98x3	1 PC Unel (Schuko + Bipasso)	FC3009A-B0000490	173,57	182,25	208,28	249,94
	●	Ø98x3	1 PC Bipasso	FC3009A-B0000410	153,47	161,14	184,16	220,99
			2 PC Bipasso	FC3009A-B0000420	200,38	210,40	240,46	288,55

Prices 04/25 in euros
without VAT

CLASSIQUE - EXPORT STANDARD SOCKETS

Diagrams	Back box colour	Size (mm)	Fittings	Reference	Cold finishes	Warm finishes	Special finishes	Shiny Gilding
	●	142x80x3	1 PC Schuko + 1 control element	FC3002A-C1610010	159,80	167,79	191,76	230,11
			1 PC Schuko + 2 control elements	FC3002A-C1610020	182,98	192,13	219,58	263,50
	●	80x142x3	1 control element + 1 PC Schuko	FC3003A-C1610010	159,80	167,79	191,76	230,11
			2 control elements + 1 PC Schuko	FC3003A-C1610020	182,98	192,13	219,58	263,50
	●	142x80x3	2 PC Schuko	FC3002A-B0000260	169,82	178,31	203,78	244,54
		142x80x3	2 PC Schuko + Covers (horizontal)	FC3002A-F0000260	395,09	414,84	474,11	568,93
		80x142x3	2 PC Schuko + Covers (vertical)	FC3003A-F0000260				
	●	142x80x3	1 PC Schuko + 1 DIN base	FC3002A-B0053480	156,43	164,25	187,72	225,26
			1 PC Schuko + 2 DIN bases	FC3002A-B0053550	176,24	185,05	211,49	253,79
	●	142x80x3	1 PC Schuko + 1 Speaker	FC3002A-B0048160	172,23	180,84	206,68	248,02
	●	142x80x3	1 PC Schuko + 1 TV outlet	FC3002A-B0059080	147,06	154,41	176,47	211,76
			1 PC Schuko + 2 TV outlets	FC3002A-B0059150	157,50	165,38	189,00	226,80
	●	142x80x3	1 PC Schuko + 1 TV-FM-SAT	FC3002A-B0008000	204,66	214,89	245,59	294,71
	●	142x80x3	1 PC Schuko + 1 RJ45	FC3002A-B0011480	176,88	185,72	212,26	254,71
			1 PC Schuko + 2 RJ45	FC3002A-B0011550	217,13	227,99	260,56	312,67
	●	142x80x3	1 PC Schuko + 1 A USB power	FC3002A-B0029681	242,10	254,21	290,52	348,62
			1 PC Schuko + 1 C USB power- 20W					
	●	142x80x3	1 PC Unel + 1 PC Bipasso	FC3002A-B0084980	217,34	228,21	260,81	312,97
			1 PC Unel + 2 PC Bipasso	FC3002A-B0085050	264,25	277,46	317,10	380,52

Other USB models on page 5
Price on request

Prices 04/25 in euros
without VAT

CLASSIQUE - EXPORT STANDARD SOCKETS

Diagrams	Back box colour	Size (mm)	Fittings	Reference	Cold finishes	Warm finishes	Special finishes	Shiny Gilding
	●	205x80x3	3 PC Schuko	FC3004A-B0000270	268,36	281,78	322,03	386,44
	●	205x80x3	2 PC Schuko + 1 TV outlet	FC3004A-B0059090	245,61	257,89	294,73	353,68
	●		2 PC Schuko + 2 TV outlets	FC3004A-B0059160	256,04	268,84	307,25	368,70
	●	205x80x3	2 PC Schuko + 1 TV-FM-SAT	FC3004A-B0008010	303,20	318,36	363,84	436,61
	●	205x80x3	1 PC Schuko + 1 TV outlet + 1 RJ45	FC3004A-B1633240	252,67	265,30	303,20	363,84
	●		1 PC Schuko + 2 TV outlets + 1 RJ45	FC3004A-B1633450	263,11	276,27	315,73	378,88
	●	205x80x3	1 PC Schuko + 1 TV-FM-SAT + 1 RJ45	FC3004A-B1053510	310,25	325,76	372,30	446,76
	●	205x80x3	2 PC Schuko + 1 RJ45	FC3004A-B0011490	275,43	289,20	330,52	396,62
●	2 PC Schuko + 2 RJ45		FC3004A-B0011560	315,67	331,45	378,80	454,56	
	●	267x80x3	4 PC Schuko	FC3006A-B0000280	344,18	361,39	413,02	495,62
	●	267x80x3	3 PC Schuko + 1 TV outlet	FC3006A-B0059100	321,43	337,50	385,72	462,86
	●		3 PC Schuko + 2 TV outlets	FC3006A-B0059170	331,86	348,45	398,23	477,88
	●	267x80x3	3 PC Schuko + 1 TV-FM-SAT	FC3006A-B0008020	379,01	397,96	454,81	545,77
	●	267x80x3	2 PC Schuko + 1 TV outlet + 1 RJ45	FC3006A-B1633250	328,49	344,91	394,19	473,03
	●		2 PC Schuko + 2 TV outlets + 1 RJ45	FC3006A-B1633460	338,92	355,87	406,70	488,04
	●	267x80x3	2 PC Schuko + 2 RJ45	FC3006A-B0011560	358,30	376,22	429,96	515,95
	●		3 PC Schuko + 1 RJ45	FC3006A-B0011500	351,25	368,81	421,50	505,80
●	267x80x3	3 PC Schuko + 2 RJ45	FC3006A-B0011570	391,49	411,06	469,79	563,75	

Prices 04/25 in euros
without VAT

ELLIPSE COLLECTION

SPECIFICATIONS

General

- Switches, reading lamps and sockets
- Protection index: IP20 (*IP21 on request*)
- Products must be installed indoors and earthed
- Cleaning only with a soft and dry duster, no product

Covering plate

- Solid brass 3mm thick
- With straight edges and visible screws
- **Screwless option available for some models – please contact us. Prices for backplates – p. 72**
- Finishes: Nickel, Chrome, Bronze médaille, Cuivre, Doré, Canon de fusil... (p.59)

Control mechanisms

- Elongated base - Ellipse, Seattle or JMA lever (with additional charge) and lighting option or oblong push button
- Chrome-plated on cold and special finishes, golden on warm finishes
- Automatic connection by default, screw connection on request

SIZES & BACK BOXES

Sizes (in mm)	Recommended back boxes
∅98 - 80x80 - 115x80 - 142x80	Mixed MELJAC, for dry partition and masonry
38x133	Narrow MELJAC, for masonry only

Can be adapted for other retail boxes: please contact us

How to fix?



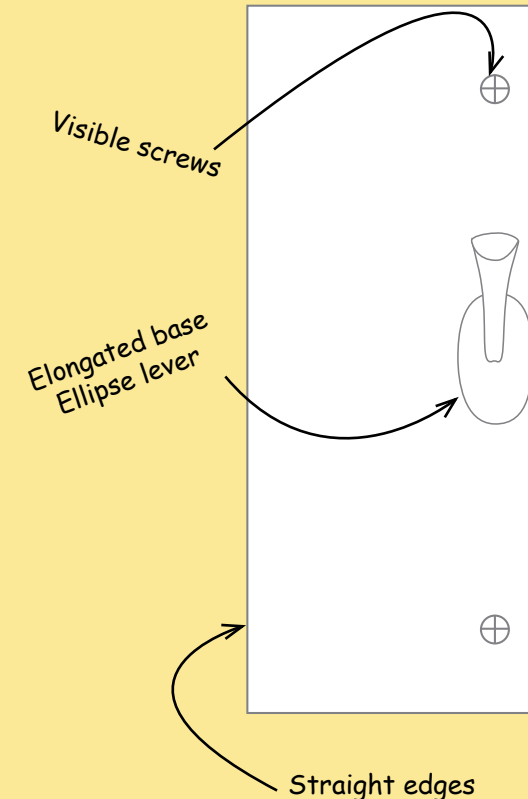
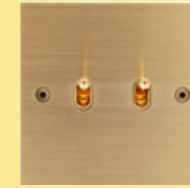

The covering plate is directly screwed onto the back box.



ORIGINE
FRANCE®
GARANTIE

BVCert. 6012053

ELLIPSE

Diagrams	Back box colour	Size (mm)	Fittings	Reference	Cold finishes	Warm finishes	Special finishes	Shiny Gilding
		80x80x3	1 control element	FE3008B-A1100010	138,84	145,78	166,61	199,93
			2 control elements	FE3008B-A1100021	203,88	214,07	244,66	293,59
		∅98x3	1 control element	FE3009B-A1100010	171,61	180,19	205,93	247,12
			2 control elements	FE3009B-A1100021	236,65	248,48	283,98	340,78

Control elements



V&V

Inv auto

BP

Prices for Ellipse and Seattle toggles only



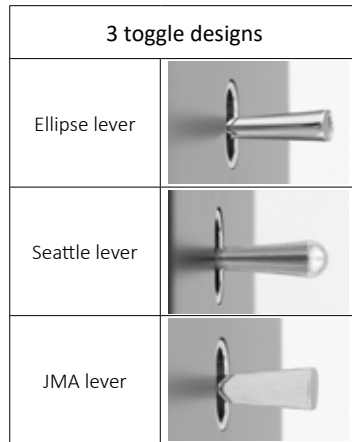



JMA lever: 28,39 € additional charge

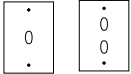

	Additional charges				
	Fittings		Bespoke options		
	Gold or chrome standard version	Chromé vif or gilding	Other color chart finishes	Polished mirror effect	Backlit
Ellipse lever	✓		✓ 17,47	or ✓ + 39,31	+ ✓ + 21,61
Seattle lever	✓		✓ 17,47	or ✓ + 39,31	+ ✓ + 21,61
JMA lever	✓ + 28,39		X		











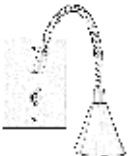

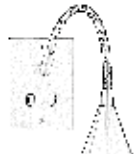

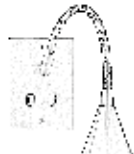
Prices 04/25 in euros without VAT

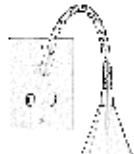
ELLIPSE

Diagrams	Back box colour	Size (mm)	Fittings	Reference	Cold finishes	Warm finishes	Special finishes	Shiny Gilding
	●	80x115x3	1 control element	FE3001B-A1100010	146,93	154,28	176,32	211,58
			2 control elements	FE3001B-A1100020	211,96	222,56	254,35	305,22
	●	80x115x3	3 control elements in triangle	FE3001B-A1100031	277,01	290,86	332,41	398,89
	●	80x115x3	4 control elements	FE3001B-A1100040	342,05	359,15	410,46	492,55
	●	38x91x3	1 control element	FE3011B-A1100010	138,84	145,78	166,61	199,93
	○	38x133x3	1 control element	FE3010B-A1100010	146,93	154,28	176,32	211,58
			2 control elements	FE3010B-A1100020	211,96	222,56	254,35	305,22
	●	38x175x3	3 control elements	FE3012B-A1100030	298,57	313,50	358,28	429,94

Prices 04/25 in euros
without VAT

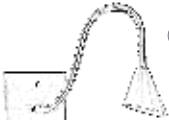
ELLIPSE

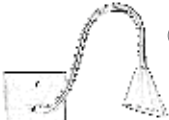
Tulipe reading lamps		Back box colour	Size (mm)	Fittings	Reference	Cold finishes	Warm finishes	Special finishes	Shiny Gilding
 	●	80x115x3	bend 0°	FE3001B-M1000020	402,85	422,99	483,42	580,10	
			bend 135°	FE3001B-M1000010					
 	●	80x115x3	bend 0° + 1 control element	FE3001B-M1000080	467,89	491,28	561,47	673,76	
			bend 135° + 1 control element	FE3001B-M1000070					
 	○	38x133x3	bend 0° + 1 control element	FE3010B-M1000080	467,89	491,28	561,47	673,76	
			bend 135° + 1 control element	FE3010B-M1000070					
 	●	80x115x3	bend 0° + 2 control elements	FE3001B-M1000380	532,93	559,58	639,52	767,42	
			bend 135° + 2 control elements	FE3001B-M1000370					
 	●	80x115x3	bend 0°	FE3001B-M1000050	402,85	422,99	483,42	580,10	
			bend 135°	FE3001B-M1000040					
 	●	80x115x3	bend 0° + 1 control element	FE3001B-M1000110	467,89	491,28	561,47	673,76	
			bend 135° + 1 control element	FE3001B-M1000100					
 	○	38x133x3	bend 0° + 1 control element	FE3010B-M1000110	467,89	491,28	561,47	673,76	
			bend 135° + 1 control element	FE3010B-M1000100					
 	●	80x115x3	bend 0° + 2 control elements	FE3001B-M1000410	532,93	559,58	639,52	767,42	
			bend 135° + 2 control elements	FE3001B-M1000400					

Please see technical details
from page 66

Tulipe straight cone











Tulipe beveled cone



Prices 04/25 in euros
without VAT

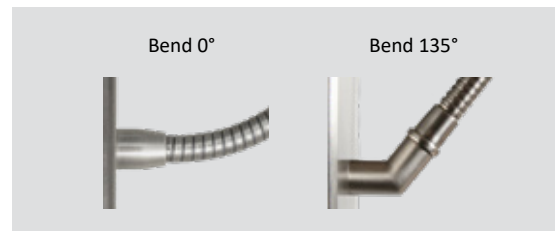

ELLIPSE

Roseau reading lamps	Back box colour	Size (mm)	Fittings	Reference	Cold finishes	Warm finishes	Special finishes	Shiny Gilding
 	●	80x115x3	bend 0°	FE3001B-M2000020	341,79	358,88	410,15	492,18
			bend 135°	FE3001B-M2000010				
 	●	80x115x3	bend 0° + 1 control element	FE3001B-M2000080	406,82	427,16	488,18	585,82
			bend 135° + 1 control element	FE3001B-M2000070				
 	○	38x133x3	bend 0° + 1 control element	FE3010B-M2000080	406,82	427,16	488,18	585,82
			bend 135° + 1 control element	FE3010B-M2000070				
 	●	80x115x3	bend 0° + 2 control elements	FE3001B-M2000380	471,86	495,45	566,23	679,48
			bend 135° + 2 control elements	FE3001B-M2000370				





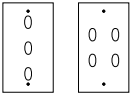
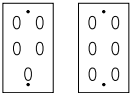
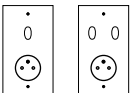
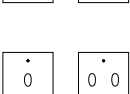
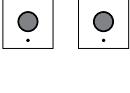
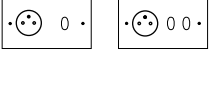
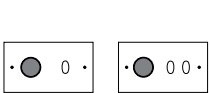
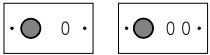

Prices 04/25 in euros
without VAT

ELLIPSE

Diagrams	Back box colour	Size (mm)	Fittings	Reference	Cold finishes	Warm finishes	Special finishes	Shiny Gilding
	●	80x142x3	3 control elements	FE3003B-A1100030	298,57	313,50	358,28	429,94
	●	80x142x3	4 control elements	FE3003B-A1100040	363,60	381,78	436,32	523,58
	●	80x142x3	5 control elements	FE3003B-A1100050	428,64	450,07	514,37	617,24
	●	80x142x3	6 control elements	FE3003B-A1100060	493,68	518,36	592,42	710,90
	●	80x142x3	1 control element + 1 PC	FE3003B-C0010010	194,22	203,93	233,06	279,67
	●	80x142x3	2 control elements + 1 PC	FE3003B-C0010020	259,28	272,24	311,14	373,37
	●	80x142x3	1 control element + Var E	FE3003B-K1000313	409,69	430,17	491,63	589,96
	●	80x142x3	2 control elements + 1 Var E	FE3003B-K1000333	474,73	498,47	569,68	683,62
	●	142x80x3	1 PC + 1 control element	FE3002B-C0010010	194,22	203,93	233,06	279,67
	●	142x80x3	1 PC + 2 control elements	FE3002B-C0010020	259,28	272,24	311,14	373,37
	●	142x80x3	1 Var E + 1 control element	FE3002B-K1000313	409,69	430,17	491,63	589,96
	●	142x80x3	1 Var E + 2 control elements	FE3002B-K1000333	474,73	498,47	569,68	683,62

Prices 04/25 in euros
without VAT

ELLIPSE - EXPORT STANDARD SOCKETS

Diagrams	Back box colour	Size (mm)	Fittings	Reference	Cold finishes	Warm finishes	Special finishes	Shiny Gilding
	●	142x80x3	1 PC Schuko + 1 control element	FE3002B-C1610010	201,67	211,75	242,00	290,40
	●	142x80x3	1 PC Schuko + 2 control elements	FE3002B-C1610020	266,71	280,05	320,05	384,06
	●	80x142x3	1 control element + 1 PC Schuko	FE3003B-C1610010	201,67	211,75	242,00	290,40
	●	80x142x3	2 control elements + 1 PC Schuko	FE3003B-C1610020	266,71	280,05	320,05	384,06

Prices 04/25 in euros
without VAT

DAMIER COLLECTION

SPECIFICATIONS

General

- Collection designed for low voltage 12V currents (home automation) and adaptable to high voltage 230V upon request
- Protection index: IP20 (IP21 on request)
- Products must be installed indoors and earthed
- Cleaning only with a soft and dry duster, no product

Covering plate

- Solid brass 3mm thick
- With straight edges and non-visible screws (possible with visible screws: contact us)
- Finishes: Nickel, Chrome, Bronze médaille, Cuivre, Doré, Canon de fusil... (p.59)

Control mechanisms

- Square push button 14x14mm in relief or flush
- Other button shapes possible (round, oval, triangular, rectangular...)
- In the same finish as the covering plate
- Screw connection

SIZES & BACK BOXES

Sizes (in mm)	Back box
80x80 - 115x80 - 142x80	Mixed MELJAC, for dry partition and masonry

How to fix?



The mounting plate with mechanisms screws directly onto the back box.
The covering plate snaps onto the mounting plate.

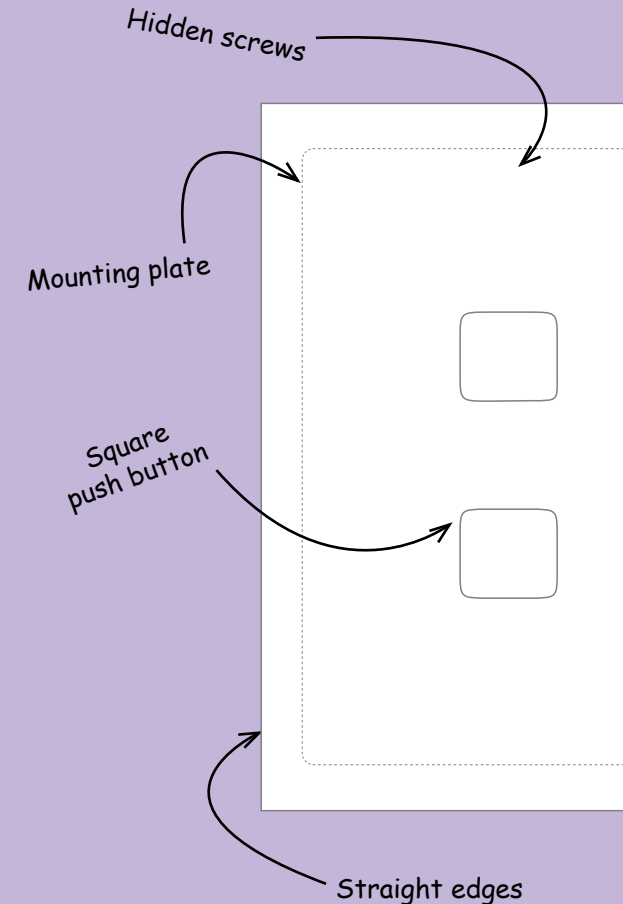

BVCert. 6012053

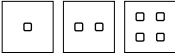

DAMIER

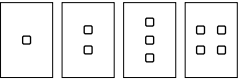
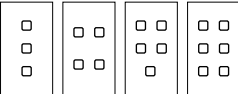
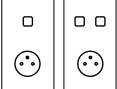
Diagrams	Back box colour	Size (mm)	Fittings	Reference	Cold finishes	Warm finishes	Special finishes	Shiny Gilding
	●	80x80x3	1 BP	FK3008D-K2000130	172,44	181,06	206,93	248,32
			2 BP	FK3008D-K2000140	205,56	215,84	246,67	296,00
			4 BP	FK3008D-K2000160	265,26	278,52	318,31	381,97
	●	80x80x3	1 BPE	FK3008D-K2000310	182,31	191,43	218,77	262,53
	●	80x115x3	1 BP	FK3001D-K2000130	180,53	189,56	216,64	259,97
			2 BP	FK3001D-K2000140	213,65	224,33	256,38	307,66
			3 BP	FK3001D-K2000150	244,61	256,84	293,53	352,24
			4 BP	FK3001D-K2000160	273,36	287,03	328,03	393,64
	●	80x142x3	3 BP	FK3003D-K2000150	272,71	286,35	327,25	392,70
			4 BP	FK3003D-K2000160	301,46	316,53	361,75	434,10
			5 BP	FK3003D-K2000170	342,51	359,64	411,01	493,21
			6 BP	FK3003D-K2000180	383,54	402,72	460,25	552,30
	●	80x142x3	1 BP + 1 PC	FK3003D-K2500130	234,38	246,10	281,26	337,51
			2 BP + 1 PC	FK3003D-K2500140	267,50	280,88	321,00	385,20

To specify :
 - BP in 12V or 230V
 - BP in relief or flush

Optional 230V BPE
 Price on request

Prices 04/25 in euros
 without VAT

Button shapes available



Square



Triangle



Round



Rectangle



Oval

Back-lighting option:



See page 64

CANNELÉE COLLECTION

Designed by Jean-Michel WILMOTTE

SPECIFICATIONS

General

- Switches, reading lamp and sockets (variation only with push buttons or automatic switches)
- Protection index: IP20
- Products must be installed indoors and earthed
- Cleaning only with a soft and dry duster, no product

Covering plate

- Solid brass 5,5mm thick
- With straight edges and non-visible screws
- Different finishes are available on this mount (see page 59)

Control mechanisms

- Elongated base - Ellipse, Seattle or JMA lever or oblong push button
- Chrome-plated on cold and special finishes, golden on warm finishes
- Automatic connection by default, screw connection on request

SIZES & BACK BOXES

Sizes (in mm)	Recommended back boxes
80x80 - 151x80	Type LEGRAND 80051 / LEGRAND 80052

How to fix?



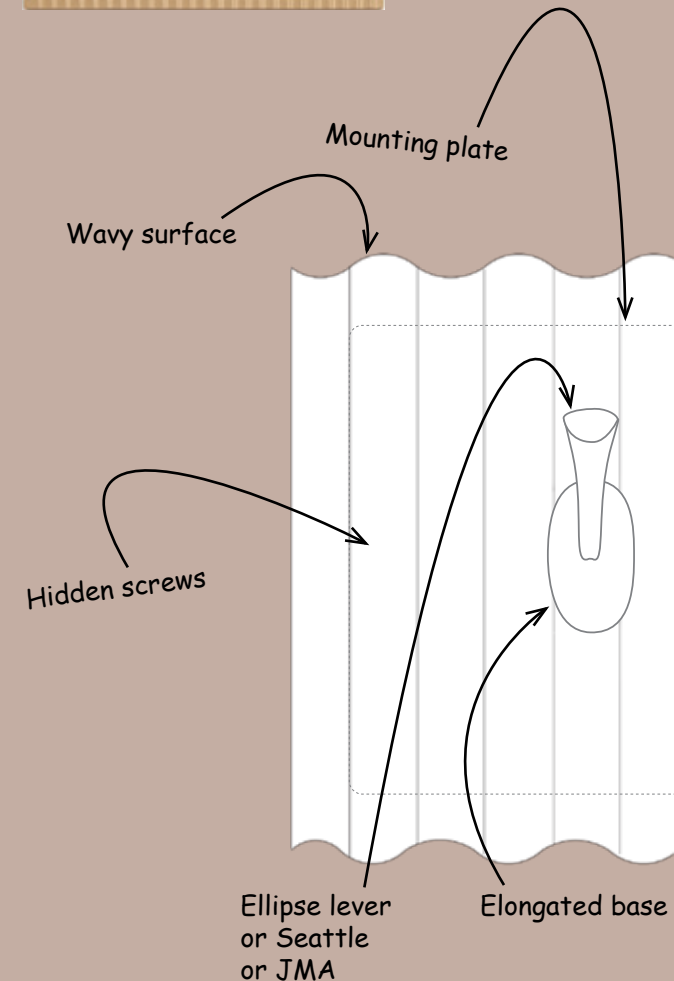







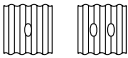









The mounting plate with mechanisms screws directly onto the back box.
The covering plate is magnetized onto the mounting plate.



ORIGINE
FRANCE®
GARANTIE

BVCert. 6012053

CANNELÉE

Diagrams	Back box colour	Size (mm)	Fittings	Reference	**Cold finishes	**Warm finishes	**Special finishes	Shiny Gilding
		80x80x5,5	1 control element	FW5017K-A1100010	188,12	197,53	225,74	270,89
		80x80x5,5	2 control elements	FW5017K-A1100021	284,00	298,20	340,80	408,96
		80x80x5,5	1 PC 2x10/16A+T	FW5017K-B0000010	129,39	135,86	155,27	186,32
		80x80x5,5	1 RJ45	FW5017K-B0000730	149,96	157,46	179,95	215,94
		80x80x5,5	1 USB socket	FW5017K-B0001211	208,68	219,11	250,42	300,50
		80x80x5,5	1 cable outlet	FW5017K-B0001290	129,10	135,56	154,92	185,90
		80x80x5,5	1 TV outlet	FW5017K-B0001700	129,58	136,06	155,50	186,60
		80x80x5,5	1 Thermostat Schneider S520509	FW5017K-K1000127	536,18	562,99	643,42	772,10
		151x80x5,5	3 control elements	FW5022K-A1100032	438,68	460,61	526,42	631,70
		151x80x5,5	4 control elements	FW5022K-A1100042	534,57	561,30	641,48	769,78
		151x80x5,5	5 control elements	FW5022K-A1100052	630,45	661,97	756,54	907,85

**Available finishes =  page 59

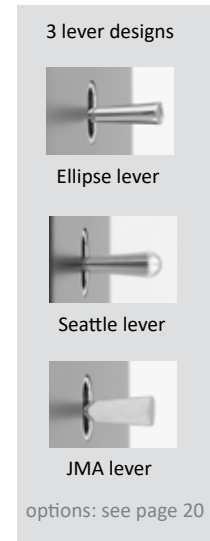
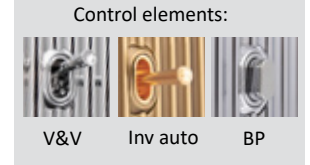













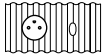

Prices for Ellipse and Seattle toggles only

JMA lever:
28,39 € additional charge

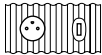
Prices 04/25 in euros
without VAT

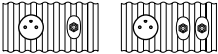
CANNELÉE

Diagrams	Back box colour	Size (mm)	Fittings	Reference	**Cold finishes	**Warm finishes	**Special finishes	Shiny Gilding
		151x80x5,5	2 PC 2x10/16A+T	FW5022K-B0000020	225,34	236,61	270,41	324,49
		151x80x5,5	2 RJ45 3 RJ45	FW5022K-B0000740 FW5022K-B0000750	266,50 324,25	279,83 340,46	319,80 389,10	383,76 466,92
		151x80x5,5	1 PC + 1 control element	FW5022K-C0010010	284,08	298,28	340,90	409,08
		151x80x5,5	1 PC + 2 control elements	FW5022K-C0010020	379,96	398,96	455,95	547,14
		151x80x5,5	1 PC + 1 RJ45 1 PC + 2 RJ45	FW5022K-B0010640 FW5022K-B0010710	245,93 303,67	258,23 318,85	295,12 364,40	354,14 437,28
		151x80x5,5	1 PC + 1 USB socket	FW5022K-B0028840	250,33	262,85	300,40	360,48
		151x80x5,5	1 PC + 1 TV outlet 1 PC + 2 TV outlets	FW5022K-B0058240 FW5022K-B0058310	225,53 262,89	236,81 276,03	270,64 315,47	324,77 378,56

**Available finishes =  page 59

Silkscreen printing option,
contact us

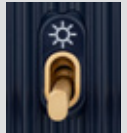

See page 62

Prices 04/25 in euros
without VAT

SOLARIS COLLECTION

Designed by Marc NEWSON

SPECIFICATIONS

General

- Designed for low voltage (smart homes), can be adapted for line voltage
- Switches and sockets (variation only with push buttons or automatic switches)
- Protection index: IP20
- Products must be installed indoors and earthed
- Cleaning only with a soft and dry duster, no product

Covering plate

- Solid brass 3mm thick
- With straight edges, rounded corners and non-visible screws
- Different finishes are possible (see page 59)

Control mechanisms

- Round base - Flattened toggle or flush concave push button
- Toggle in the same colour as the plate, shiny black base ring, black push button
- Automatic connection by default for automatic reversers (screw connection on request)
- Screw connection for push buttons

SIZES & BACK BOXES

Sizes (in mm)	Back boxes
84x84 - 84x120 - 84x144 - 210x84	Mixed MELJAC, for dry partition and masonry

How to fix?

The mounting plate with mechanisms screws directly onto the back box.
The covering plate is clipped onto the mounting plate.

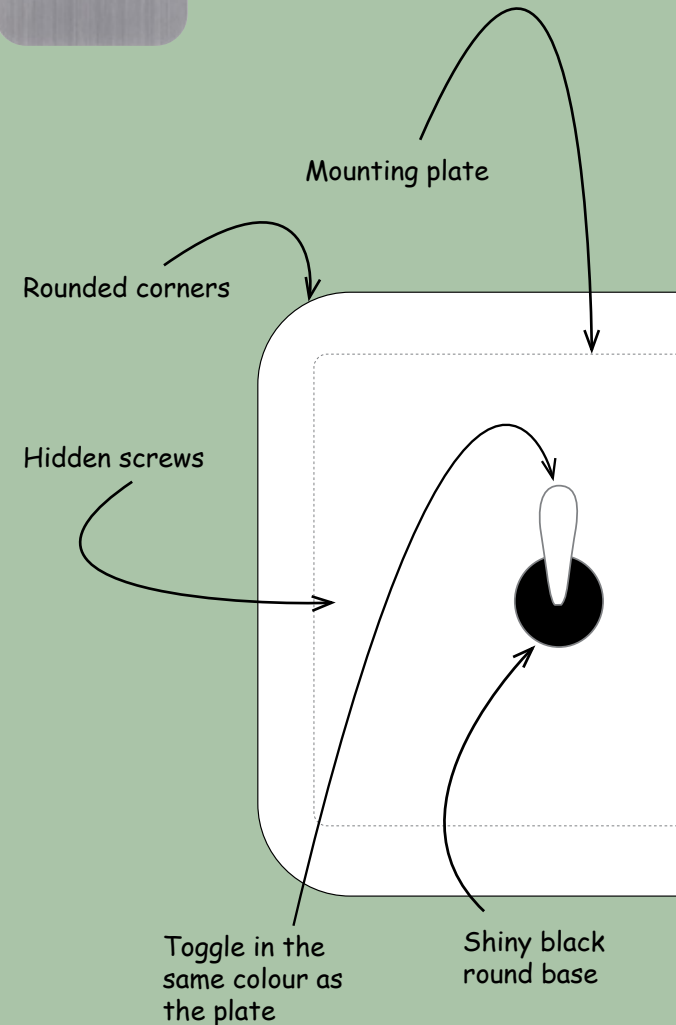

BVCert. 6012053

SOLARIS

Diagrams	Back box colour	Size (mm)	Fittings	Reference	**Cold finishes	**Warm finishes	**Special finishes	Shiny Gilding
		84x84x3	1 BP 2 BP	FJ3208M-K2500070 FJ3208M-K2500080	197,07 231,85	206,92 243,44	236,48 278,22	283,78 333,86
		84x84x3	1 lever 2 levers	FJ3208M-A1100010 FJ3208M-A1100020	219,12 316,08	230,08 331,88	262,94 379,30	315,53 455,16
		84x84x3	1 lever + 1 BP	FJ3208M-K2500130	294,03	308,73	352,84	423,41
		84x84x3	1 Thermostat Schneider S520509	FJ3208M-K1000127	530,68	557,21	636,82	764,18
		84x120x3	1 BP 2 BP 4 BP	FJ3201M-K2500070 FJ3201M-K2500080 FJ3201M-K2500100	210,77 245,54 291,00	221,31 257,82 305,55	252,92 294,65 349,20	303,50 353,58 419,04
		84x120x3	1 lever 2 levers 4 levers	FJ3201M-A1100010 FJ3201M-A1100020 FJ3201M-A1100040	232,82 329,77 523,69	244,46 346,26 549,87	279,38 395,72 628,43	335,26 474,86 754,12
		84x120x3	1 lever + 1 BP 3 BP + 1 lever	FJ3201M-K2500130 FJ3201M-K2500170	307,72 360,79	323,11 378,83	369,26 432,95	443,11 519,54
		84x120x3	2 BP + 2 levers 1 BP + 3 levers	FJ3201M-K2500140 FJ3201M-K2500160	439,47 501,65	461,44 526,73	527,36 601,98	632,83 722,38
		120x84x3	1 BP 2 BP 4 BP	FJ3200M-K2500070 FJ3200M-K2500080 FJ3200M-K2500100	208,70 243,47 288,93	219,14 255,64 303,38	250,44 292,16 346,72	300,53 350,59 416,06
		120x84x3	1 lever 2 levers	FJ3200M-A1100010 FJ3200M-A1100020	230,75 327,71	242,29 344,10	276,90 393,25	332,28 471,90
		120x84x3	1 BP + 1 lever	FJ3200M-K2500130	305,66	320,94	366,79	440,15

**Available finishes = page 59

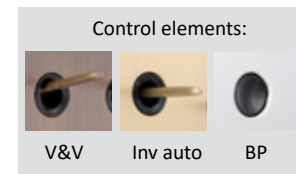

Prices 04/25 in euros
without VAT

SOLARIS

Diagrams	Back box colour	Size (mm)	Fittings	Reference	**Cold finishes	**Warm finishes	**Special finishes	Shiny Gilding
	●	84x144x3	2 BP	FJ3203M-K2500020	271,14	284,70	325,37	390,44
			3 BP	FJ3203M-K2500030	289,42	303,89	347,30	416,76
			4 BP	FJ3203M-K2500040	316,60	332,43	379,92	455,90
			6 BP	FJ3203M-K2500120	394,16	413,87	472,99	567,59
	●	84x144x3	2 levers	FJ3203M-A1100020	355,37	373,14	426,44	511,73
			3 levers	FJ3203M-A1100030	452,33	474,95	542,80	651,36
			4 levers	FJ3203M-A1100040	549,29	576,75	659,15	790,98
			6 levers	FJ3203M-A1100060	743,20	780,36	891,84	1070,21
	●	84x144x3	3 levers + 3 BP	FJ3203M-K2500150	580,29	609,30	696,35	835,62
	●	144x84x3	2 BP	FJ3202M-K2500020	271,14	284,70	325,37	390,44
			3 BP	FJ3202M-K2500030	289,42	303,89	347,30	416,76
			6 BP	FJ3202M-K2500120	394,16	413,87	472,99	567,59
	●	144x84x3	2 levers	FJ3202M-A1100020	341,70	358,79	410,04	492,05
			3 levers	FJ3202M-A1100030	434,93	456,68	521,92	626,30

**Available finishes = page 59

Prices 04/25 in euros
without VAT

SOLARIS

Diagrams	Back box colour	Size (mm)	Fittings	Reference	**Cold finishes	**Warm finishes	**Special finishes	Shiny Gilding
		84x84x3	1 PC	FJ3208M-B0000010	147,91	155,31	177,49	212,99
		84x84x3	1 RJ45	FJ3208M-B0000730	187,38	196,75	224,86	269,83
			2 RJ45	FJ3208M-B0000740	252,61	265,24	303,13	363,76
		84x84x3	1 A USB socket	FJ3208M-B0001211	227,64	239,02	273,17	327,80
			1 C USB socket					
		84x84x3	1 AA double USB socket	FJ3208M-B0001221	234,81	246,55	281,78	338,13
			1 AC double USB socket	FJ3208M-B0001223	262,53	275,66	315,04	378,04
			1 CC double USB socket	FJ3208M-B0001223	262,53	275,66	315,04	378,04
		144x84x3	1 PC + 1 control element	FJ3202M-C0010010	284,16	298,37	340,99	409,19
		144x84x3	2 PC	FJ3202M-B0000020	212,94	223,59	255,53	306,64
		144x84x3	1 PC + 1 RJ45	FJ3202M-B0010640	227,45	238,82	272,94	327,53
		144x84x3	1 PC + 1 A USB socket	FJ3202M-B0002884	292,66	307,30	351,20	421,44
			1 PC + 1 C USB socket- 20W					
		210x84x3	3 PC	FJ3204M-B0000030	309,58	325,06	371,50	445,80
		210x84x3	2 PC + 1 AA double USB socket	FJ3204M-B0028921	396,48	416,30	475,78	570,94
		210x84x3	1 PC + 1 AA double USB socket + 1 RJ45	FJ3204M-B1214291	410,98	431,53	493,18	591,81

**Available finishes = page 59

*Other USB models on page 5
Price on request*

*Prices 04/25 in euros
without VAT*

TOURNAIRE COLLECTION

SPECIFICATIONS

General

- Switches
- Products must be installed indoors and earthed
- Cleaning only with a soft and dry duster, no product

Covering plate

- 6mm-thick cast bronze (brass)
- With straight edges and non-visible screws
- 5 models replicating the six iconic motifs of the jewellery designer TOURNAIRE
- Three of the jewellery designer's 5 iconic motifs can be inlaid with precious stones: Alchimie, Bas-relief and Engrenages.
- Example of finishes: Argent Patiné (G5), Nickel Vieilli, Nickel Noir Brillant, Dorure (1N), Bronze Moyen dépoli, Dorure (3N) Vieillie...

Control mechanisms

- Elongated base - Straight lever or Seattle lever with lighting option or push button
- Automatic connection by default, screw connection on request

SIZES & BACK BOXES



Sizes (in mm)	Recommended back boxes
85x115	Mixed MELJAC, for dry partition and masonry

How to fix?

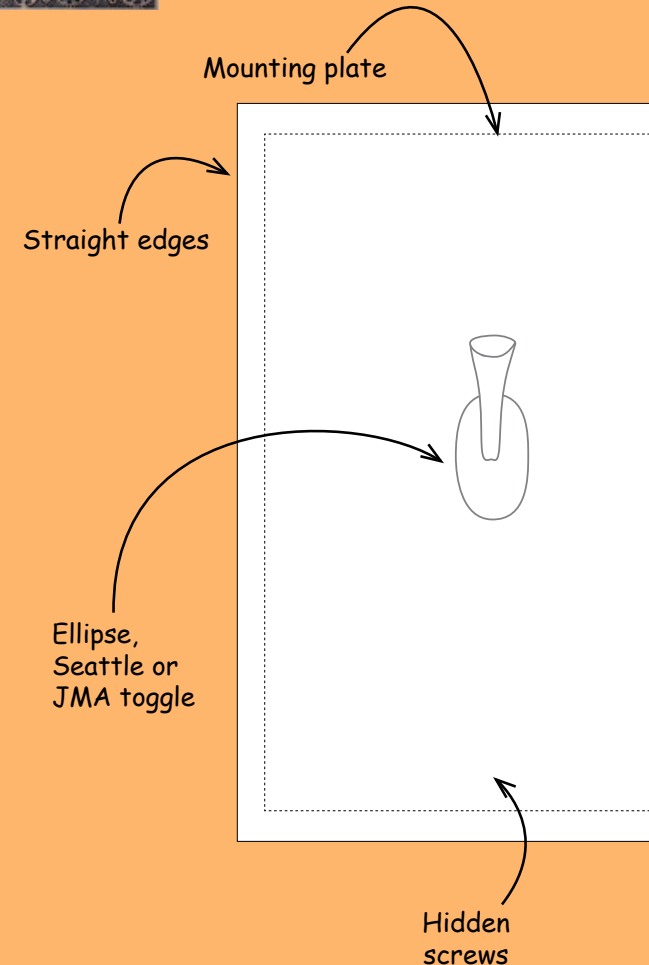
The mounting plate with mechanisms screws directly onto the back box.
The covering plate snaps onto the mounting plate.



TOURNAIRE COLLECTION

Diagrams	Back box colour	Size (mm)	Fittings	Reference	Special finishes
	●	85x115x6	1 control element	FA6003D-A1100010	895,65
	●	85x115x6	2 control elements	FA6003D-A1100020	1019,64
	●	85x115x6	4 control elements	FA6003D-A1100040	1267,69

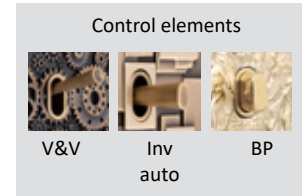

Prices 04/25 in euros
without VAT

Pattern (to be specified when ordering)



Alchimie*

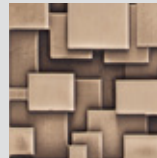

Construction

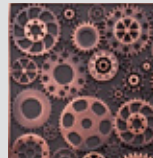

Engrenages*



Bas-relief*



Catacombes

*Models that can be set with precious stones.

STUDIO COLLECTION

SPECIFICATIONS

General

- Switches
- Products must be installed indoors and earthed (*except for low current*)
- Cleaning only with a soft and dry duster, no product

Plaque de recouvrement

- Solid brass 3mm thick
- *Straight edges or chamfered (depending on the finish) screwless
- 7 finishes

Control mechanisms

- Round base - Droplet lever or push button
- Automatic connection by default, screw connection on request

SIZES & BACK BOXES



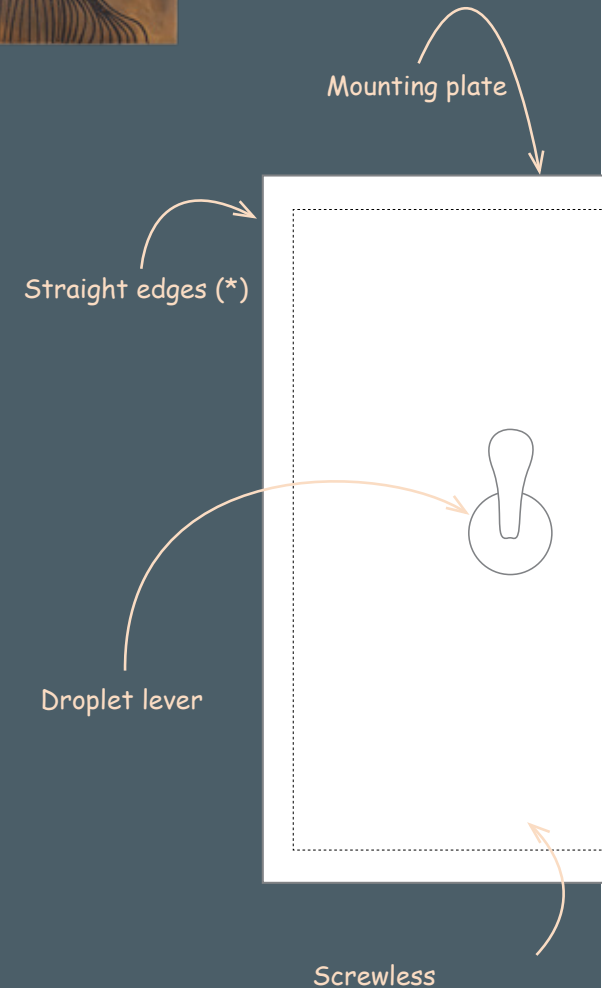
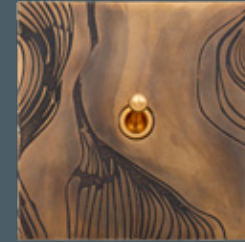

Sizes (in mm)	Recommended back boxes
80x80 - 115x80	Mixed MELJAC, for dry partition and masonry

How to fix?

The covering plate is directly screwed onto the back box.



STUDIO COLLECTION

Diagrams	Back box colour	Size (mm)	Fittings	Reference	Special finishes
		80x80x3	Méandres	FT3008D-A1100010AB	447,73
			Forest Automne } Forest Printemps }	FT3008D-A1100010AD	413,90
			Lagon	FT3008D-A1100010AG	274,80
			Plumes	FT3008D-A1100010AE	278,34
			Tissage	FT3008D-A1100021AF	329,37
			Noir Martelé	FT3008D-A1100010AC	286,85
					80x115x3
Forest Automne } Forest Printemps }	FT3001D-A1100010AD	470,25			
Lagon	FT3001D-A1100010AG	315,75			
Plumes	FT3001D-A1100010AE	318,58			
Tissage	FT3001D-A1100010AF	380,95			
Noir Martelé	FT3001D-A1100010AC	379,21			

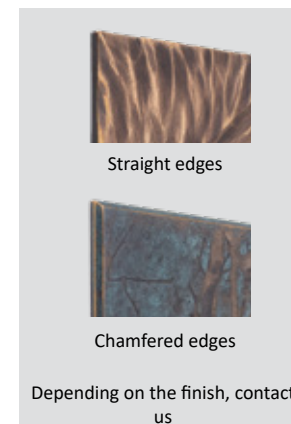
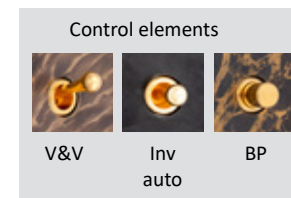

Prices 04/25 in euros without VAT

Pattern (to be specified when ordering)

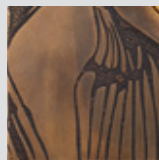

Méandres

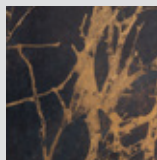

Forest Automne

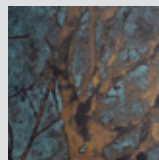

Forest Printemps

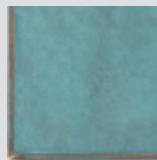

Lagon

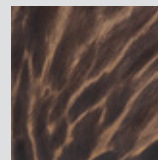

Plumes



Tissage

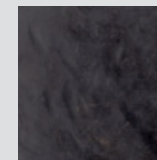

Noir Martelé

SOL COLLECTION

SPECIFICATIONS

General

- Sockets with water-resistant cover
- Protection index: IP44
- Products must be installed indoors and earthed (*except for low current*)
- Cleaning only with a soft and dry duster, no product

Covering plate

- Solid brass 10mm thick (*14mm for international*)
- With straight edges and non-visible screws
- Water-resistant cover(s)
- Finishes: Nickel, Chrome, Bronze médaille, Cuivre, Doré, Canon de fusil... (p.59)

SIZES & BACK BOXES







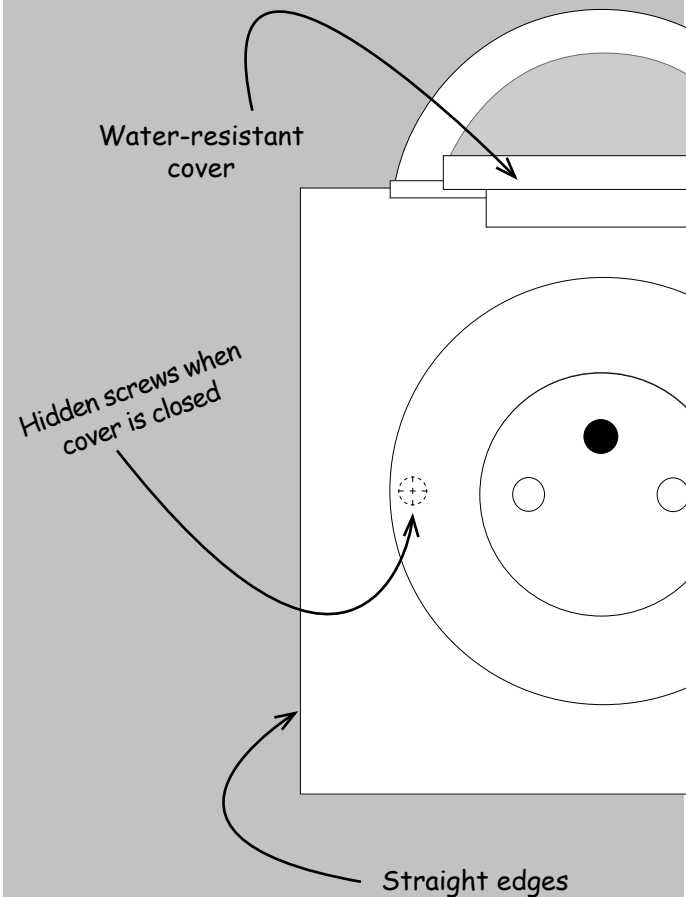

Sizes (in mm)	Back boxes
Ø100 - 100x100 - 180x100 - 180x200	Water-resistant MELJAC with installation template, for masonry only

How to fix?

The back box + installation template set must be sealed flush with the floor.
Then the installation template must be replaced by the covering plate with mechanisms and screws.

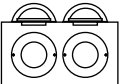

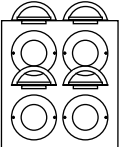
BVCert. 6012053

Diagrams	Back box colour	Size (mm)	Fittings	Reference	Cold finishes	Warm finishes	Special finishes	Shiny Gilding
		100x100x10	1 PC 2x10/16A+T	FS1000D-B0000010	632,11	663,72	758,53	910,24
			1 RJ45	FS1000D-B0000730	718,24	754,15	861,89	1034,27
			1 TV outlet	FS1000D-B0001700	752,22	789,83	902,66	1083,19
			2 TV outlets	FS1000D-B0001710	760,47	798,49	912,56	1095,08
		Ø100x10	1 PC 2x10/16A+T	FS1003D-B0000010	626,35	657,67	751,62	901,94
			1 RJ45	FS1003D-B0000730	712,49	748,11	854,99	1025,99
			1 TV outlet	FS1003D-B0001700	746,46	783,78	895,75	1074,90
			2 TV outlets	FS1003D-B0001710	754,71	792,45	905,65	1086,78
		180x100x10	2 PC 2x10/16A+T	FS1001D-B0000020	1046,34	1098,66	1255,61	1506,73
			2 RJ45	FS1001D-B0000740	1218,61	1279,54	1462,33	1754,80
			2 TV outlets	FS1001D-B0001710	1156,04	1213,84	1387,25	1664,70
			1 PC + 1 RJ45	FS1001D-B0010640	1132,47	1189,09	1358,96	1630,75
			1 PC + 1 TV outlet	FS1001D-B0058240	1166,44	1224,76	1399,73	1679,68
			1 RJ45 + 1 TV outlet	FS1001D-B0060760	1252,58	1315,21	1503,10	1803,72
		180x200x10	4 PC 2x10/16A+T	FS1002D-B0000040	2034,24	2135,95	2441,09	2929,31
			2 PC + 2 RJ45	FS1002D-B0010720	2206,51	2316,84	2647,81	3177,37
			3 PC + 1 RJ45	FS1002D-B0010660	2120,38	2226,40	2544,46	3053,35
			2 PC + 2 TV outlets	FS1002D-B0052720	2274,47	2388,19	2729,36	3275,23
			3 PC + 1 TV outlet	FS1002D-B0052660	2154,35	2262,07	2585,22	3102,26

SOL - EXPORT STANDARD SOCKETS

Diagrams	Back box colour	Size (mm)	Fittings	Reference	Cold finishes	Warm finishes	Special finishes	Shiny Gilding
	●	100x100x14	1 PC Schuko	FS1400D-B0000250	696,41	731,23	835,69	1002,83
			1 RJ45	FS1400D-B0000730	778,92	817,87	934,70	1121,64
			1 TV outlet	FS1400D-B0001700	812,91	853,56	975,49	1170,59
			2 TV outlets	FS1400D-B0001710	951,66	999,24	1141,99	1370,39
	●	Ø100x14	1 PC Schuko	FS1403D-B0000250	650,31	682,83	780,37	936,44
			1 RJ45	FS1403D-B0000730	732,82	769,46	879,38	1055,26
			1 TV outlet	FS1403D-B0001700	766,79	805,13	920,15	1104,18
			2 TV outlets	FS1403D-B0001710	775,04	813,79	930,05	1116,06
	●	180x100x14	2 PC Schuko	FS1401D-B0000260	1139,70	1196,69	1367,64	1641,17
			2 RJ45	FS1401D-B0000740	1304,73	1369,97	1565,68	1878,82
			2 TV outlets	FS1401D-B0001710	1372,69	1441,32	1647,23	1976,68
			1 PC Schuko + 1 RJ45	FS1401D-B0011480	1222,22	1283,33	1466,66	1759,99
			1 PC Schuko + 1 TV outlet	FS1401D-B0059080	1256,19	1319,00	1507,43	1808,92
			1 RJ45 + 1 TV outlet	FS1401D-B0060760	1338,71	1405,65	1606,45	1927,74
	●	180x200x14	4 PC Schuko	FS1402D-B0000280	2192,37	2301,99	2630,84	3157,01
			2 PC Schuko + 2 RJ45	FS1402D-B0011560	2357,39	2475,26	2828,87	3394,64
			3 PC Schuko + 1 RJ45	FS1402D-B0011500	2274,88	2388,62	2729,86	3275,83
			2 PC Schuko + 2 TV outlets	FS1402D-B0059160	2447,62	2570,00	2937,14	3524,57
			3 PC Schuko + 1 TV outlet	FS1402D-B0059100	2308,86	2424,30	2770,63	3324,76

To integrate any other mechanism, contact us.

Prices 04/25 in euros without VAT

VOLUMES COLLECTION

SPECIFICATIONS

General

- Switches, bells, power sockets
- Protection index: IP20
- Products must be installed indoors and earthed
- Cleaning only with a soft and dry duster, no product

Volume

- Solid brass
- Non-visible screws
- Finishes: Nickel, Chrome, Bronze médaille, Cuivre, Doré, Canon de fusil... (p.59)

Control mechanisms

- Round base - Droplet lever or push button
- Chrome-plated on cold and special finishes, golden on warm finishes
Exception: for DOME, 1920, 1951 and rectangular bell block, BP is in the same finish as the object
- Screw connection

SIZES & BACK BOXES

Sizes (in mm)	Recommended back boxes
Macaroons - 1920 - 1930 - 1951 - Dome Square and rectangular bell blocks	LEGRAND 89246, for masonry only
Skate - Palet	LEGRAND 80051, for dry partition only

How to fix?



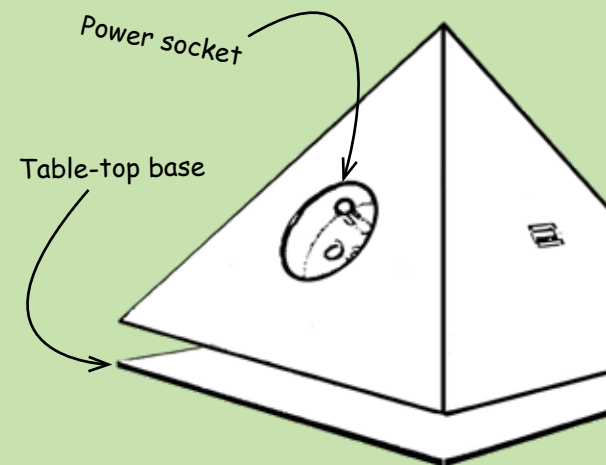
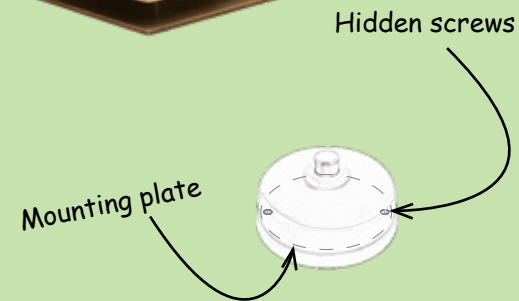
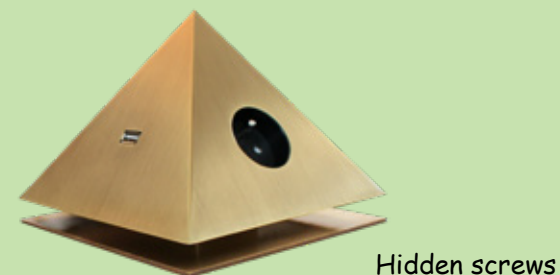









The mounting plate screws directly onto the back box. Then the volume fitted mechanisms with snaps or screws onto the mounting plate. Except for 1951, 1920, rectangular bell block and macaroon, mechanisms are on the mounting plate.



ORIGINE
FRANCE®
GARANTIE

BVCert. 6012053

VOLUMES

Bells	Back box colour	Size (mm)	Fittings	Reference	Cold finishes	Warm finishes	Special finishes	Shiny Gilding
SQUARE BELL BLOCK 		L.48xl.48xH.17	1 BP 12V	FV9000Z-A1100070	267,47	280,84	320,96	385,15
1951 		L.55xl.55xH.17	1 BP 12V	FV9001Z-A1100070	531,18	557,74	637,42	764,90
DOME 		Ø55xH.36	1 BP 12V	FV9002Z-A1100070	341,26	358,32	409,51	491,41
1920 		L.94xl.52xH.20	1 BP 12V	FV9018Z-A1100070	1238,34	1300,26	1486,01	1783,21
IGULAR BELL BLOCK 		L.70xl.46xH.17	1 BP 12V	FV9004Z-A1100070	341,26	358,32	409,51	491,41
MACAROON 		Ø50xH.23	1 BP 12V	FV9005Z-A1100070	188,03	197,43	225,64	270,77







L : length

W : width



H : height

Prices 04/25 in euros
without VAT

VOLUMES

Volumes to fix		Back box colour	Size (mm)	Fittings	Reference	Cold finishes	Warm finishes	Special finishes	Shiny Gilding
1930			Ø58xH.32	1 V&V 230V	FV9009Z-A1100010	251,29	263,85	301,55	361,86
				1 BP 230V	FV9009Z-A1100070	246,03	258,33	295,24	354,29
SKATE			L.80xl.38xH.110	1 V&V 230V	FV9010Z-A1100010	785,26	824,52	942,31	1130,77
				1 BP 230V	FV9010Z-A1100070	785,26	824,52	942,31	1130,77
PALET			Ø80xH.19	1 V&V 230V	FV9003Z-A1100010	298,54	313,47	358,25	429,90
				1 BP 230V	FV9003Z-A1100070	298,54	313,47	358,25	429,90

Volumes to put on

PYRAMID			B.105xH.60	1 BP 12V	FV9006Z-A1100070	1074,02	1127,72	1288,82	1546,58
			L.70xl.42xH.36	1 BP 230V	FV9007Z-A1100070	341,26	358,32	409,51	491,41
PAPER-WEIGHT			L.103xl.42xH.36	2 BP 230V	FV9008Z-A1100080	414,83	435,57	497,80	597,36
			L.106xl.42xH.36	3 BP 230V	FV9011Z-A1100090	496,38	521,20	595,66	714,79

L : length



W : width

H : height

B : base

Prices 04/25 in euros
without VAT

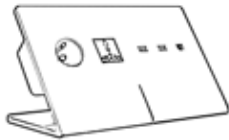
VOLUMES

Models to fix	Size (mm)	Fittings	Reference	Cold finishes	Warm finishes	Special finishes	Shiny Gilding
Pyramid 	B:L180xI.180 H.146	4 sided power strip 2 PC + 1 RJ45 + 1 Double USB	FV9042Z-B1214300	1170,73	1229,27	1404,88	1685,86
Z 	L268xI.114 H.139	Power strip 1 PC 2x10/16A+T + 1 universal outlet + 2 USB + 1 RJ45 Cable 2 m	FV9044Z-B1302010	2343,88	2461,07	2812,66	3375,19
Pupitre 	L200xI.106 H.90	1 PC + 1 universal outlet + 1 double USB	FV9039Z-B1001500	1030,62	1082,15	1236,74	1484,09

Other combinations on request. (PC, RJ45, USB, V&V, BP...), contact us

L : length

W : width

H : height



B : base

Prices 04/25 in euros
without VAT

VOLUMES

Models to put fix	Size (mm)	Fittings	Reference	Cold finishes	Warm finishes	Special finishes	Shiny Gilding
CHARGEUR IPAD 	L.140xI.142 H. 119	Ipap charger support Interchangeable connector compatible with Ipap and Ipap mini	FV9026Z-B0002130	1026,28	1077,59	1231,54	1477,85

Models to put on

CALYPSO 	L.158xI.70 H. 110	Power strip 2 PC 2x10/16A+T + 2 USB + 1 RJ45 Cable 2 m	FV9040Z-B1302010	878,29	922,20	1053,95	1264,74
TOTEM 	B: 120x120 H. 700	Power strip 4 PC 2x10/16A+T + 3 RJ45 Cable 2 m	FV9023Z-B0010800	1201,48	1261,55	1441,78	1730,14

L : length

W : width

H : height

B : base

Prices 04/25 in euros
without VAT

PIERROT COLLECTION

SPECIFICATIONS

General

- Switches and sockets
- Protection index: IP20 (*IP21 on request*)
- Products must be installed indoors and earthed
- Cleaning only with a soft and dry duster, no product

Covering plate

- Toughened glass 4mm thick
- With chamfer and visible screws
- Choice of colour in the RAL colour chart

Control mechanisms

- Round base - Droplet lever or push button
- Chrome-plated or golden
- Automatic connection by default, screw connection on request

SIZES & BACK BOXES

Sizes (in mm)	Back boxes
∅98 - 80x80 - 115x80 - 80x142	Mixed MELJAC, for dry partition and masonry

How to fix?





The covering plate is directly screwed onto the back box.

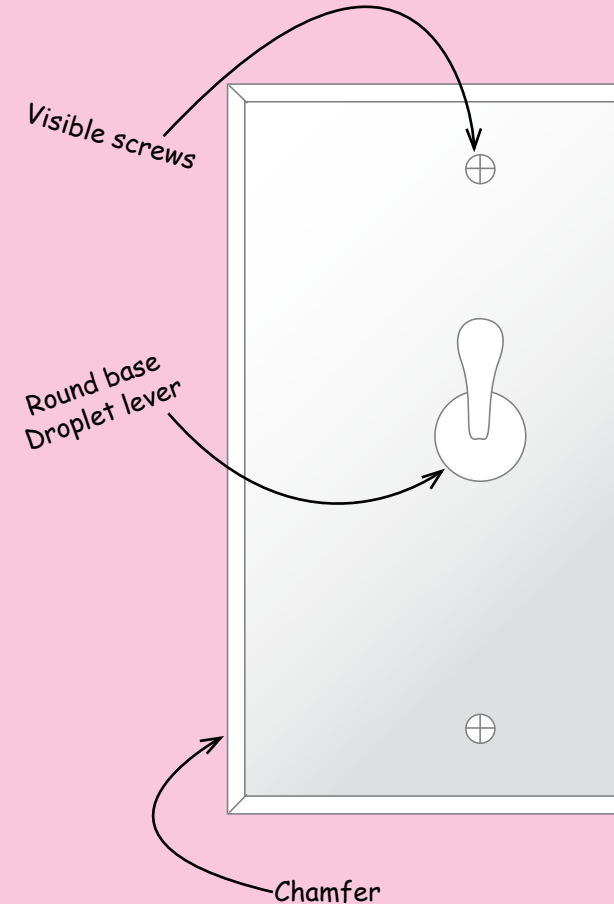

BVCert. 6012053

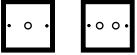

PIERROT

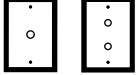
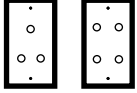
Diagrams	Back box colour	Size (mm)	Fittings	Reference	Any RAL colour
	●	80x80x4	1 control element	FP4108A-A1100010	222,71
			2 control elements	FP4108A-A1100021	299,36
	●	80x80x4	1 PC	FP4108A-B0000010	218,56
			1 RJ45	FP4108A-B0000730	242,54
			1 USB	FP4108A-B0001211	299,79
	●	∅98x4	1 control element	FP4109A-A1100010	231,22
			2 control elements	FP4109A-A1100021	307,87
	●	∅98x4	1 PC	FP4109A-B0000010	227,07
	●	80x115x4	1 control element	FP4101A-A1100010	218,62
			2 control elements	FP4101A-A1100020	295,27
	●	80x142x4	3 control elements in triangle	FP4103A-A1100031	407,53
			4 control elements	FP4103A-A1100040	484,18

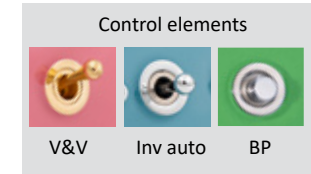

Prices 04/25 in euros
without VAT

PLEXIGLASS PRODUCTS

SPECIFICATIONS

General

- Switches and sockets
- Protection index: IP20 (IP21 on request)
- Products must be installed indoors and earthed (except for low current)
- Cleaning only with a soft and dry duster

Covering plate

- Solid brass 3mm thick
- With chamfer and visible screws
- Transparent

Control mechanisms

- Round base - Droplet lever or push button
- Chrome-plated or golden
- Automatic connection by default, screw connection on request

SIZES & BACK BOXES







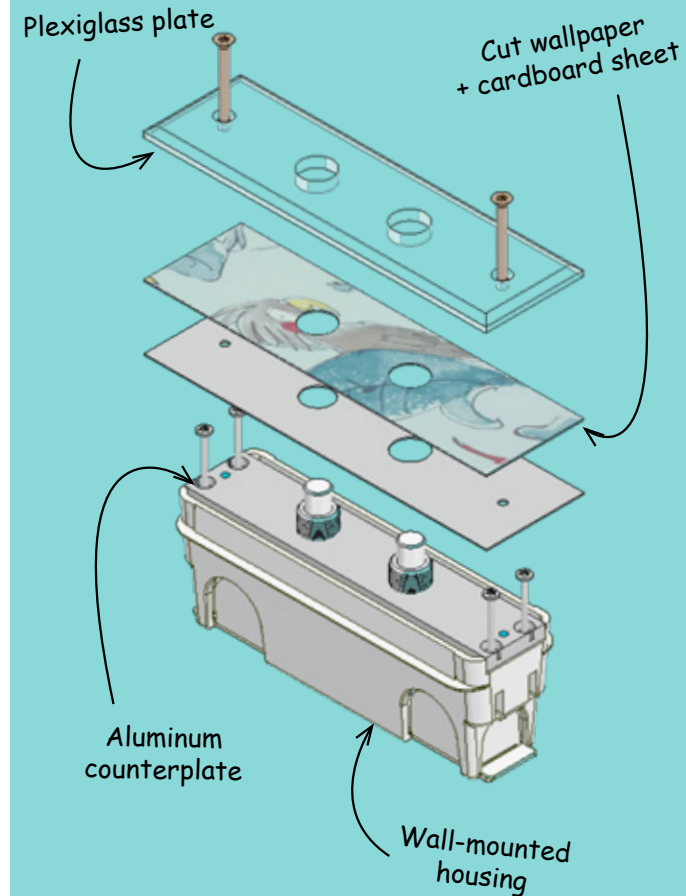
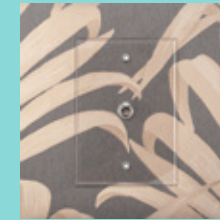



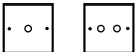



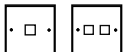

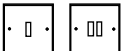



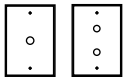



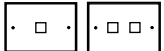

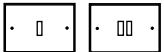
Sizes (in mm)	Recommended back boxes
80x80 - 80x115 - 80x142 - 115x80 - 142x80	Mixed MELJAC, for dry partition and masonry
38x91 - 38x133	Narrow MELJAC, for masonry only

How to fix?

The aluminum counterplate equipped with the mechanisms screws directly onto the wall-mounted housing. The plexi cover plate is fixed onto this counterplate with 2 screws. To be fitted beforehand: the cut wallpaper and the card provided.



PLEXIGLASS

Diagrams	Back box colour	Size (mm)	Fittings	Reference	Transparent
		80x80x3	1 control element 2 control elements	FX3008A-A1100010ZZ FX3008A-A1100021ZZ	89,55 104,25
		80x80x3	1 PC 2x10/16A+T	FX3008A-B0000010ZZ	87,93
		80x80x3	1 RJ45 2 RJ45	FX3008A-B0000730ZZ FX3008A-B0000740ZZ	104,16 160,34
		80x80x3	1 Type A USB socket 1 double Type A USB socket	FX3008A-B0001211ZZ FX3008A-B0001221ZZ	172,26 179,44
	 	38x91x3 38x133x3	1 control element 2 control elements	FX3011A-A1100010ZZ FX3010A-A1100020ZZ	89,33 107,79
		80x115x3	1 control element 2 control elements	FX3001A-A1100010ZZ FX3001A-A1100020ZZ	97,42 120,6
		115x80x3	1 PC 2x10/16A+T	FX3000A-B0000010ZZ	100,63
		115x80x3	1 RJ45 2 RJ45	FX3000A-B0000730ZZ FX3000A-B0000740ZZ	115,14 155,39
		115x80x3	1 Type A USB socket 1 double Type A USB socket	FX3000A-B0001211ZZ FX3000A-B0001221ZZ	180,36 187,33
		142x80x3	2 PC 2x10/16A+T	FX3002A-B0000020ZZ	138,98
		142x80x3	1 PC + 2 control elements	FX3002A-C0010020ZZ	181,57
		142x80x3	1 PC + 2 RJ45	FX3002A-B0010710ZZ	189,75
		142x80x3	1 PC + 1 double Type A USB socket	FX3002A-B0028911ZZ	234,49

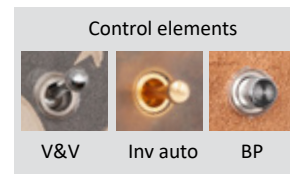

Other types of sockets available on demand

Other combinations of mechanisms on request, Please contact us

Prices 04/25 in euros without VAT

LIMOGES CLASSIQUE COLLECTION

SPECIFICATIONS

General

- Switches
- Protection index: IP20 (*IP21 on request*)
- Products must be installed indoors and earthed
- Cleaning only with a soft and dry duster, no product

Covering plate

- Limoges porcelain 3mm thick
- With straight edges and non-visible screws
- Porcelain glazed (*white colour by default, contact us for other colours*) or biscuit (*white colour only*)

Control mechanisms

- Round base - Droplet lever or push button
- Chrome-plated or golden
- Automatic connection by default, screw connection on request

SIZES & BACK BOXES

Sizes (in mm)	Type of back box
80x80 - 115x80 - 142x80	Mixed MELJAC, for dry partition and masonry
38x133	Narrow MELJAC, for masonry only





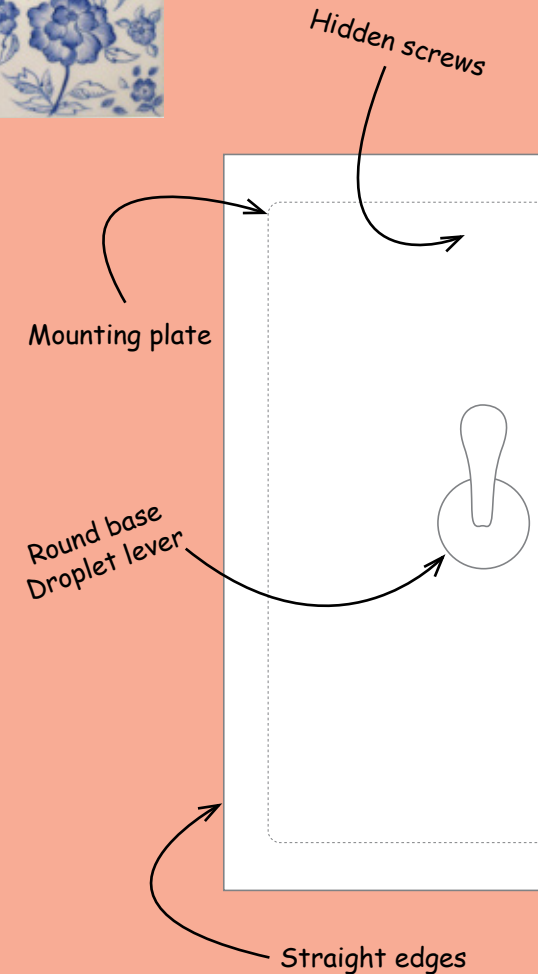
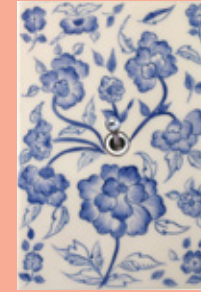



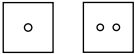

How to fix?

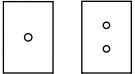
The mounting plate with mechanisms screws directly onto the back box.
The covering plate snaps onto the mounting plate.

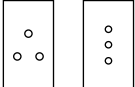

BVCert. 6012053

LIMOGES CLASSIQUE

Diagrams	Back box colour	Size (mm)	Fittings	Reference	White colour
		80x80x3	1 control element	FL3008D-A1100010	185,93
			2 control elements	FL3008D-A1100020	282,64
		80x115x3	1 control element	FL3001D-A1100010	192,89
			2 control elements	FL3001D-A1100020	289,59
		80x142x3	3 V&V , Inv auto or BPE in triangle	FL3003D-A1100031	408,57
			3 BP in line	FL3003D-A1100090	
		80x142x3	4 control elements	FL3003D-A1100040	505,27
		38x133x3	1 control element	FL3010D-A1100010	192,89
			2 control elements	FL3010D-A1100020	289,59

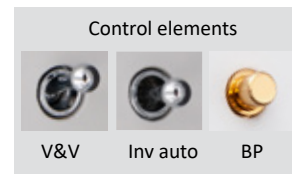

Prices 04/25 in euros
without VAT

LIMOGES ELLIPSE COLLECTION

SPECIFICATIONS

General

- Switches
- Protection index: IP20 (*IP21 on request*)
- Products must be installed indoors and earthed
- Cleaning only with a soft and dry duster, no product

Covering plate

- Limoges porcelain 3mm thick
- With straight edges and non-visible screws
- Porcelain glazed (*white colour by default, contact us for other colours*) or biscuit (*white colour only*)

Control mechanisms

- Elongated base - Straight lever or Seattle lever with lighting option or oblong push button
- Chrome-plated or golden
- Automatic connection by default, screw connection on request

SIZES & BACK BOXES

Sizes (in mm)	Type of back box
80x80 - 115x80 - 142x80	Mixed MELJAC, for dry partition and masonry
38x133	Narrow MELJAC, for masonry only





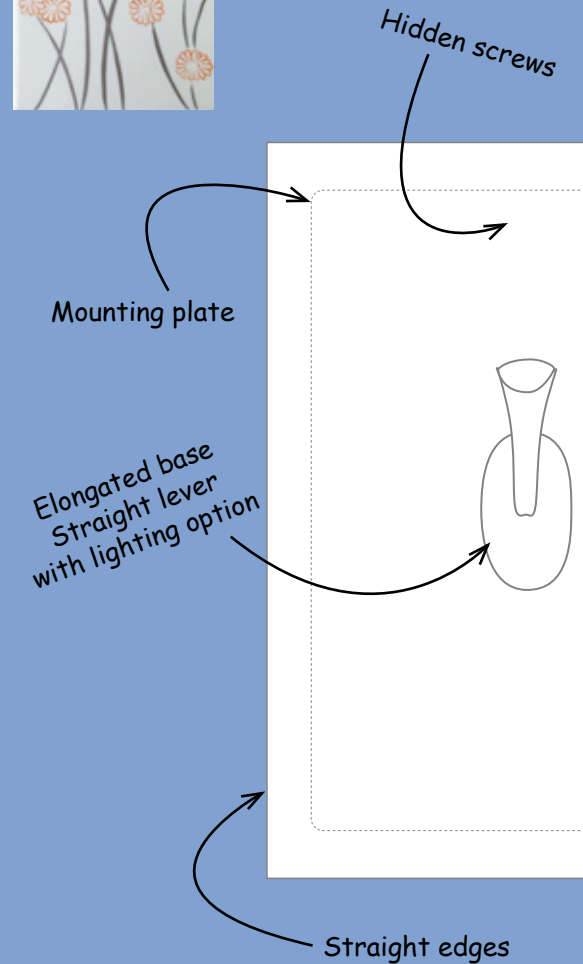
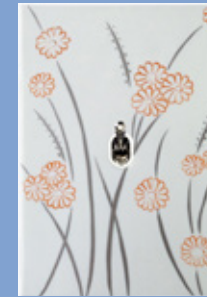



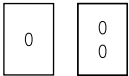

How to fix?

The mounting plate with mechanisms screws directly onto the back box.
The covering plate snaps onto the mounting plate.

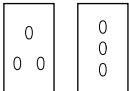

BVCert. 6012053

LIMOGES ELLIPSE

Diagrams	Back box colour	Size (mm)	Fittings	Reference	White colour
		80x80x3	1 control element	FM3008D-A1100010	185,93
			2 control elements	FM3008D-A1100020	282,64
		80x115x3	1 control element	FM3001D-A1100010	192,89
			2 control elements	FM3001D-A1100020	289,59
		80x142x3	3 V&V , Inv auto or BPE in triangle	FM3003D-A1100031	408,57
			3 BP in line	FM3003D-A1100090	408,57
		80x142x3	4 control elements	FM3003D-A1100040	505,27
		38x133x3	1 control element	FM3010D-A1100010	192,89
			2 control elements	FM3010D-A1100020	289,59

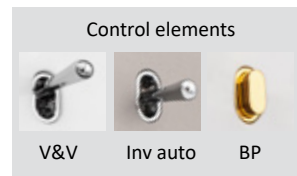

Prices for Ellipse and Seattle toggles only

JMA lever:
28,39€ additional charge

Prices 04/25 in euros
without VAT

CRESTRON CONNECTED COLLECTION

SPECIFICATIONS

General

- Collection designed for direct connection to the Crestnet bus
- Push buttons
- Protection index: IP20
- Products must be installed indoors and earthed
- Cleaning only with a soft and dry duster, no product

Covering plate

- Solid brass 3mm thick
- With straight edges and non-visible screws
- Finishes: Nickel, Chrome, Bronze médaille, Cuivre, Doré, Canon de fusil...

Control mechanisms

- Push buttons $\varnothing 12$ mm, 2 mm thick
- In the same finish as the covering plate
- Led feedback for each button
- Circuit board with integrated Crestron chip

SIZES & BACK BOXES

Sizes (in mm)	Recommended back boxes
80x115	Mixed MELJAC, for dry partition and masonry





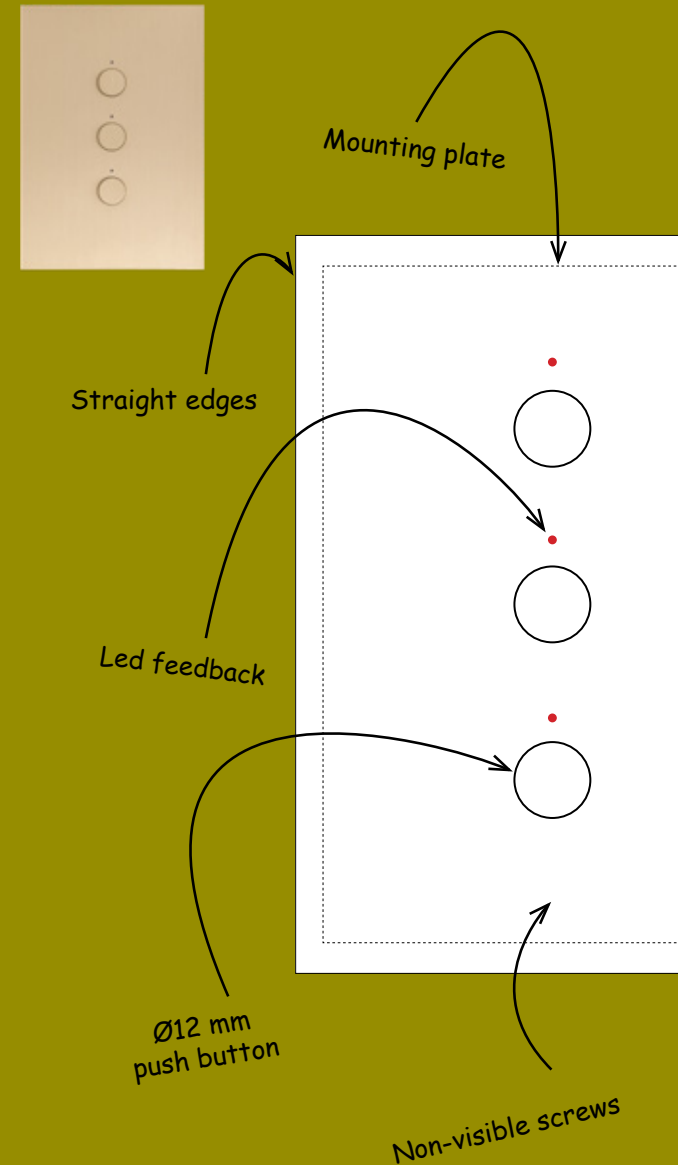



How to fix?

The mounting plate with mechanisms screws directly onto the back box.
The covering plate snaps onto the mounting plate.



BVCert. 6012053

CRESTRON CONNECTED

Diagrams	Back box colour	Size (mm)	Fittings	Reference	Cold finishes	Warm finishes	Special finishes	Shiny Gilding
		80x115x3	1 BP	FO3001C-K2500410	417,87	438,76	501,44	601,73
		80x115x3	2 BP	FO3001C-K2500420	452,59	475,22	543,11	651,73
		80x115x3	3 BP	FO3001C-K2500430	487,32	511,69	584,78	701,74
		80x115x3	6 BP	FO3001C-K2500460	591,50	621,08	709,80	851,76

Prices 04/25 in euros
without VAT

Control elements examples with options



Fittings	Reference	Price from
2 BP	FO3001C-K2500420	452,59
Engraving 1 word	FZ9999Z-ZGR0001M99	+ 10,50
Engraving 1 additional word	FZ9999Z-ZGR1001M99	+ 10,50

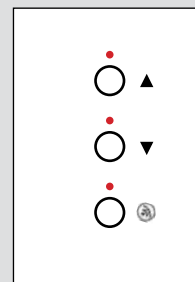

Fittings	Reference	Price from
3 BP	FO3001C-K2500430	487,32
Engraving 1 symbol	FZ9999Z-ZGR0001S99	+ 10,50
Engraving 1 additional symbol	FZ9999Z-ZGR1001S99	+ 10,50
Engraving 1 pictogram	FZ9999Z-ZGR0001P99	+ 10,50

SPOTLIGHT COLLECTION

SPECIFICATIONS

General

- Recessed spotlights for false ceiling
- Protection index: IP54 CLASS II
- Products must be installed indoors in a false ceiling and earthed
- Cleaning only with a soft and dry duster, no product

Covering plate

- Solid brass 3mm thick
- With straight edges, without screws
- Standard sizes: 58x58 mm and Ø58 mm
- Finishes: Nickel, Chrome, Bronze médaille, Cuivre, Doré, Canon de fusil... (p.59)

Technical specifications

- Direct or asymmetric LED lighting
- Power: 230V - 5W
- Beam angle: 24°.
- Light color: warm white (2700K) or cool white (4000K)



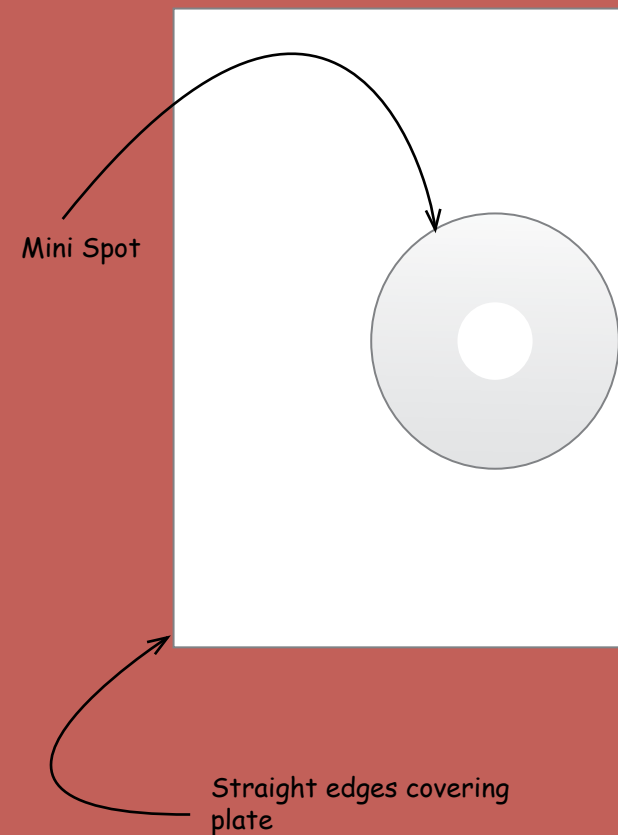

How to fix?

The transformer is fixed in the false ceiling.
The cover plate snaps onto the spotlight.



BVCert. 6012053

SPOTLIGHTS

	Diagrams	Installation	Size (mm)	Fittings	Reference	Cold finishes	Warm finishes	Special finishes	Shiny Gilding
DIRECT LIGHTING									
SQUARE		Ceiling cut Ø45mm	58x58x3	Mini Spot 2700K-warm	FB3013C-Z5000010	152,92	160,57	183,50	220,20
				Mini Spot 4000K-cold	FB3013C-Z5000020				
ROUND		Ceiling cut Ø45 mm	Ø58x3	Mini Spot 2700K-warm	FB3014C-Z5000010	156,30	164,12	187,56	225,07
				Mini Spot 4000K-cold	FB3014C-Z5000020				
ASYMMETRIC LIGHTING									
SQUARE		Ceiling cut Ø45 mm	58x58x3	Mini Spot 2700K-warm	FB3013C-Z5000011	152,92	160,57	183,50	220,20
				Mini Spot 4000K-cold	FB3013C-Z5000021				
ROUND		Ceiling cut Ø45 mm	Ø58x3	Mini Spot 2700K-warm	FB3014C-Z5000011	156,30	164,12	187,56	225,07
				Mini Spot 4000K-cold	FB3014C-Z5000021				

Direct lighting



Asymmetric lighting



Both models are available with white or black interior, to specify



















Prices 04/25 in euros without VAT

MATERIALS & FINISHES

The collections CLASSIQUE, ELLIPSE, DAMIER, ELLIOT, CANNELÉE, SOLARIS, SOL with water-resistant cover, VOLUMES, SPOTS and LAMPES are made in brass. The finishes are obtained by electrolysis.

The PIERROT collection is in toughened extra white glass. The paint is applied at the rear and highlighted by the transparency and thickness of the glass.













The LIMOGES collections are in Limoges Porcelain.

Material & fittings	Finish & description
TF Brass Cold finishes With chrome-plated V&V, BP, BPE and Inv	Nickel Brossé (FA)  <i>Stainless-steel aspect.</i>
	Nickel Brillant (FB)  <i>Mirror effect, tone slightly hotter than chrome.</i>
	Microbillé Nickel (FC)  <i>Sandy surface, matt varnish.</i>
	Chromé Mat (FD)  <i>Linear brushing. Bluish grey hue.</i>
	Chromé Vif (FE)   <i>Mirror with bluish sheens.</i>
	Canon de Fusil Anthracite (FF)   <i>Brushing. Dark grey tone, tend toward brown.</i>
	Canon de Fusil Sablé (FH)  <i>Granite aspect. Dark grey tone.</i>
TC Brass Warm finishes With golden V&V, BP, BPE and Inv	Bronze Médaille Clair (CA)   <i>Golden bronze slightly brushed. Satiny varnish.</i>
	Bronze Médaille Clair Vernis Mat (CB)  <i>Golden bronze slightly brushed. Matt varnish.</i>
	Bronze Médaille Allemand (CC)  <i>Linear brushing, medium bronze.</i>
	Bronze Médaille Foncé (CD)   <i>Dark brown hue.</i>
	Champagne (CE)   <i>Brushed brass. Matt varnish.</i>
Doré Patiné (CF)  <i>Gold yellow hue. Slightly brushed and satiny varnish.</i>	

Meljac can carry out special finishes on demand (example: different types of gilding, etc.) or customised.

Available finishes on collection Cannelée 

Available finishes on collection Solaris 

Material & fittings	Finish & description
TS Brass Special finishes With chrome or gilding controls	Nickel Noir Brillant (SA)
	Nickel Noir Mat (SB)
	Microbillé Chromé (SF)
	Argent Patiné (SE)  
	Cuivre Patiné (SG) 
	Cuivre Vieilli Bouchonné (SH) 
	Cuivre Satiné (SI)  
	Microbillé Canon de Fusil Anthracite (SM)
	Ebène (SQ)
	Canon de Fusil Belge (SP) 
	Laiton Vieilli Ciré (SR) 
D Shiny Gilding	Étain Moyen (SS) 
	Cuivre Antique (ST) 
	Antique Brass NA (SU) 
	Black Stone Chelsea (SV)
	Gilding 1 shiny (1N)  
	Epoxy Brass / Glass RAL colours With chrome-plated or golden V&V, BP, BPE and Inv
Limoges Porcelain With chrome-plated V&V, BP, BPE and Inv	
	White Glazed (LA) Shiny surface Other colours on request. Custom designs possible
	White Biscuit (LB) Matt sandblasted surface Custom designs possible

Care instructions

Metal-coated surfaces must be cleaned with a soft and dry duster only, no product.

All the products must be installed indoors.

SAMPLE BOX & TUBES

Prices and delivery time upon request



The box contains the standard finishes.

*Actual products may differ from photos

TECHNICAL INFORMATION - GENERAL

Direction of covering plate

All MELJAC products fix onto back boxes.

The screws are supplied in the same finish as plates.

By default, the axis of the cover plate screws is:

- vertical for control mechanisms (V&V, BP, BPE...)
- horizontal for sockets
- horizontal for 80x80 and Ø98 sizes

Colour of switches

On brass, the switches are:

- chrome-plated on cold and special finishes
- golden on warm finishes

Mini mechanisms (12V) are chrome-plated only

Switches are chrome-plated or golden for glass, porcelain and plexiglass.

Accessories in the same finish as the plate:

- rotary buttons for variation
- caps of mini push buttons
- square push buttons from DAMIER collection
- bell buttons of Dome, 1951, 1920 and rectangular block
- cable lead-out (cable outputs, markings)

Light label holder

Two shapes are available. Specify when ordering: rectangular or elliptical.

Position of indicators, engravings (simple, complex, light...) and light label holder

By default, MELJAC selects the most harmonious position for fittings on the covering plate.

Care instructions

Products must be installed indoors

Cleaning only with a soft and dry duster, no product

Standards

MELJAC creations are protected in France and abroad by the copyright, the registration of models and several patents.

Probate by the norms:

- NF EN 60669-1 + A1 for switches, push buttons and reversers.
- NF C 61314 for power sockets.

For probates in process, contact us.

Following the established standard NF C 15100, each plate has to be connected to earth.

Each pattern is outfitted with a patented system of connection to earth.





Stamping CE.

Protection index: IP20 except for Sol collection IP44 and water resistant spotlights IP54 CLASS II.

NB : For any special requirement, please clarify and / or provide a diagram when you place an order.

OPTIONS (ENGRAVING, TOGGLE WITH COATING)

These options are sold separately, so do not forget to specify them at the order.

	Type of option	Designation	Reference	Price
	Engraving : - standard font: Helvetica uppercase height 4mm - Russian standard font: Arial Narrow 4 mm - word, figure, symbol, triangle = simple symbol - pictogram = complex symbol	Engraving 1 word	FZ9999Z-ZGR0001M99	10,50
		Engraving 1 figure	FZ9999Z-ZGR0001C99	
		Engraving 1 symbol	FZ9999Z-ZGR0001S99	
		Engraving 1 pictogram	FZ9999Z-ZGR0001P99	
	Engraving triangles: per pair, on both sides of the switch (standard position: up/down)	Engraving 2 triangles	FZ9999Z-ZGR0002T99	21,00
	Laser engraving (<i>contact us for existing designs, we can also create new</i>)	Laser engraving 1 word	- - -	Please contact us
	Silkscreen printing (words, symbols, pictograms, photographs...)	Silkscreen printing	- - -	Please contact us
	Resin (<i>specify colour</i>)	Resin engraving 1 word	FZ9999Z-ZR00001M99	16,80
		Resin engraving 1 symbol	FZ9999Z-ZR00001S99	
		Resin engraving 1 pictogram	FZ9999Z-ZR00001P99	
	Light engraving	Light ribbon supplied in 12V or 24V (Colour of your choice)	FZ9999Z-ZGLU000199	63,00
		Additional light ribbon supplied in 12V or 24V (Colour of your choice)	FZ9999Z-ZGLU100199	
	Mirror-polished oblong base In bright chrome or gold for Ellipse lever switches	Mirror-polished	FZPLVAZ-Z0000050ZZ	39,31
	JMA lever switch subject to additional charge With oblong base	JMA lever	FZPLVAZ-Z0000040ZZ	28,39
	Additional charge for mechanism processing Processing possible on request for V&V, BP and Inv switches.	Processed mechanisms	FZPLVAZ-Z0000010ZZ	17,47
	Additional charge for black mechanism processing Processing possible on request for V&V, BP and Inv switches.	Processed black mechanisms	FZPLVAZ-Z0000010ZZ	8,94

Prices 04/25 in euros
without VAT

Examples of engravings

Words

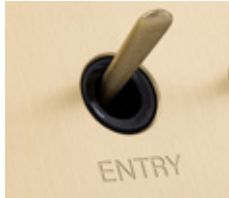

1



2



3



4

- 1 Mechanical engraving
- 2 Engraving + resin
- 3 Screen printed
- 4 Bright cut engraving

Symbols Numbers



1



2



3



4



Bespoke engraving

OPTIONS (LED INDICATORS, BACK-LIGHTING)

These options are sold separately, so do not forget to specify them at the order.

	Type of option	Designation	Reference	Price
	LED Indicator - Ø 3 mm - LED colour : Warm white, Blue, Pure Green, Yellow Green, Yellow, Orange, Red White cold	LED D3 30V-1mA (automation) LED D3 12V-1mA LED D3 24V-1mA LED D3 230V-1mA	FZLED0Z-Z00D303099 FZLED1Z-Z00D301299 FZLED1Z-Z00D302499 FZLED2Z-Z00D323099	17,10
	Oblong light base LED light strip Several colours available Interior lighting of toggle base is not available in the Cannelée collection.	LED D3 12V-1mA for Ellipse collection LED D3 24V-1mA for Ellipse collection LED D3 230V-1mA for Ellipse collection	FZLED3Z-Z00D301299 FZLED3Z-Z00D302499 FZLED3Z-Z00D323099	21,61
Back-lighting of Damier buttons Illuminated button surround Several colours available	1 colour (12V 1mA)	FZLEDZ-Z001RT01299	28,59	
	1 colour (24V 1mA)	FZLEDZ-Z001RT02499		
	1 colour (12V 1mA) night brightness	FZLEDZ-Z002RT01299	35,92	
	1 colour (24V 1mA) night brightness	FZLEDZ-Z002RT02499		
	2 colours (12V 1mA)	FZLEDZ-Z003RT01299	39,75	
	2 colours (24V 1mA)	FZLEDZ-Z003RT02499		
	2 colours (12V 1mA) night brightness	FZLEDZ-Z004RT01299	43,58	
	2 colours (24V 1mA) night brightness	FZLEDZ-Z004RT02299		

Prices 04/25 in euros
without VAT

Examples of indicator options

LED indicator

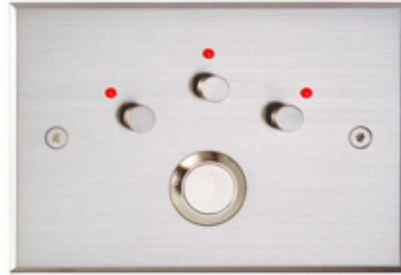

Oblong light base
Ellipse collection









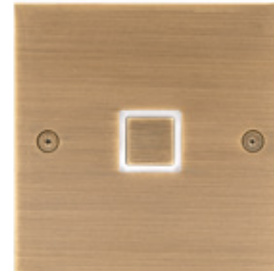





Indicator Q8 model



Backlighting
Damier collection



MECHANISMS CONTROLS, READING LAMPS

Type	Abbreviations	Symbole	Designation	Technical specifications
Switches <i>buttons and levers are chrome-plated on cold and special finishes, golden on warm finishes</i>	V&V		Toggle switch	Lever wired in one-way switch or two-way switch between 2 ignition points - automatic connection (default): 6A/250V - screw connection (on request): 6A/250V
	BP		Push button	Button wired in dimmer, one-way switch or two-way switch between 2 or more ignition points - automatic connection (default): 6A/250V - screw connection (on request): 2A/250V It MUST work with a teleruptor or a dimmer in the electrical equipment box
	BPE		Latching push button	Latching button wired in one-way switch or two-way switch between 2 ignition points - automatic connection ONLY: 6A/250V
	Inv Auto		Automatic Reverser	Three-position lever for roller shutters (2 positions + automatic return to 0) Possibility to control lighting - automatic connection (default): 6A/250V - screw connection (on request): 6A/250V Also available in manual for roller shutters only (manual return to 0)
	Mini BP		Mini push button	Button wired in dimmer, one-way switch or two-way switch between 2 or more ignition points - connection to weld: 12V It MUST work with a teleruptor or a dimmer in the electrical equipment box Silent mini BP, available on request
	square BP		Square push button	Button wired in dimmer, one-way switch or two-way switch between 2 or more ignition points - screw connection ONLY: 12V or 230V It MUST work with a teleruptor or a dimmer in the electrical equipment box
	---		Motion detector	Automatic switch - 240V - Model LEGRAND 67026 Lighting control, manual by On/Off push buttons or automatic by infrared detection
Variation	Var E Rotary dimmer		SCHNEIDER NU3514 model	200W- Universal. For LED, incandescent, halogen and transformer lamps. For use with a dimmer switch (push button).
			SCHNEIDER S520519 model	200W- Universal. For LED, incandescent, halogen and transformer lamps. For use with a toggle switch. A 60mm deep back box is recommended.
	Room thermostat		LEGRAND 76720 model	Room thermostat, optional hot/cold selector available Suitable for controlling heated ceilings and underfloor heating from 5°C to 30°C with an accuracy of +/- 0,5°C
	Room/floor thermostat		SCHNEIDER S520507 model	Electronic room thermostat with floor temperature limitation sensor, 2 integrated LEDs Suitable for controlling room temperature with floor heating systems, heating from 5°C to 45°C with an accuracy of +/- 0,5°C - Ambient option available
	Room and floor thermostat		SCHNEIDER S520509 model	Electronic room thermostat with floor temperature limitation sensor, with touch screen and pilot wire Suitable for controlling room temperature with floor heating systems, heating from 5°C to 45°C with an accuracy of +/- 0,5°C
Reading lamp	---	---	Reading lamp	Wall lamp : - Lighting (provided): 1,4 W LED (Tulipe model: 110 lumens, Roseau model: 150 lumens), supplied by a 350 mA electronic converter - Beam: 60° for Roseau model and 45°, 60° (default) or 110° for Tulipe model - Lampshade : straight or beveled cone for Tulipe model - Flexible arm : 25 cm with or without a 135° bend connection

Mechanisms provided (since 2010)

Automatic connection
(by default)



Screw connection
(on request)



Former mechanism

Screw connection
only



Connection

Use rigid cable of section 1,5 mm² stripped on 13 mm for automatic connection or 10 mm for screw connection



V&V
wired in ON/OFF function

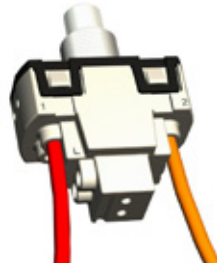

BP
wired in ON/OFF function





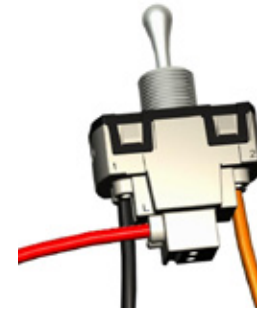













BPE
wired in two-way function



Inv Auto

MECHANISMS OUTLETS (high voltage, low voltage)

Type	Abbreviations	Symbole	Designation	Technical specifications
Power socket	PC		Power socket	French model 2x10/16A+T with child security Sockets are black by default, off-white on request
	Universal PC		Wonpro power socket	Wonpro R45 model. Universal socket 2x16A+T with child security Sockets are black by default, off-white on request Prior agreement from a control authority required
	PC Schuko		Schuko power socket	German / european model 2x10/16A+T with child security Sockets are black by default, off-white on request
	PC Bipasso		Bipasso power socket	Italian model 2x10/16A+T with child security
	PC Unel		Unel power socket (Schuko + Bipasso)	European model 2x10/16A+T with child security Sockets are black by default, off-white on request
Phone/Data Connection	RJ45 without PE		Data socket without white label holder	Model SCHNEIDER RJ1772XB12 Category 6a FTP socket
Connexion Audio/Vidéo	DIN base		Audio connector	3-pin female base (male plug on request)
	Speaker		Speaker socket	Model LEGRAND 67311 - Terminal with push/release connectors
	Flush RCA		Audio/video connector	D-serie female base
	HDMI		HD audio/video connector	Female/female connector
TV Connection	TV-FM-SAT		TV, radio and satellite antennas socket	
	TV outlet		TV antenna socket	
IT-connection	USB power		USB A power socket	- Simple : Model LEGRAND 77591 - 7,5W - Double : Model LEGRAND 67462 - 15W
			USB C power socket	- Simple : Model LEGRAND 77690 - 20W - Simple : Model LEGRAND CM0156 - 45W
				- Simple : Model SCHNEIDER S540406 - 65W
				- Double : Model LEGRAND CM0158 - 30W
			USB A+C power socket	Model NIKO 420-00513 - 17,5W
Others	---		Shaver socket	Model VIMAR 20290 It can work with european, american, british and australian plugs
	---		Cable outlet	Specify diameter
	---		Cable lead-out	Specify diameter (12mm max)

PC or PC Schuko : automatic connection

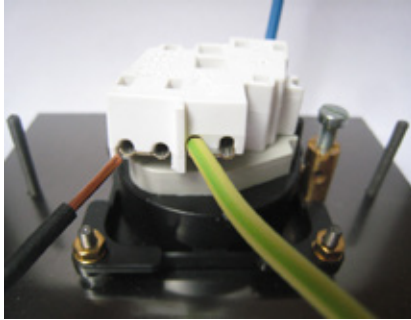

Use rigid cable of section 2,5 mm²
stripped on 13 mm



How to extract cable

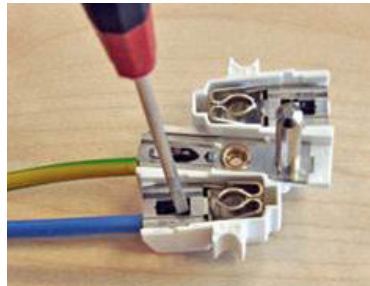

Renovation

Since 2016, MELJAC products are fitted with
a new socket mechanism (France or Schuko)
that takes less space.

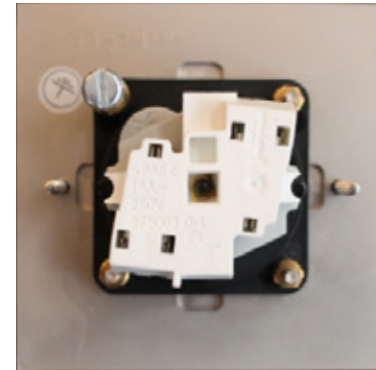

















CLASSIQUE collection plates 80x80mm can be
mounted on most of the existing back boxes
in renovation.

BACK BOXES

All MELJAC products are fixed onto back boxes. Screws are supplied in same finish as plates.

MELJAC designs its own back boxes and continues to develop new series in line with its ranges.

Type of back box	Back box overview	Back box colour	Reference	Compatible with...	Overall dimensions (L. x W. x D. in mm)	Price
<p>Mixed MELJAC back boxes for CLASSIQUE, ELLIPSE, DAMIER, SOLARIS and PIERROT collections</p> <p>Mixed models are used in masonry and dry partition with an additional kit to maintain back box into the wall.</p>			CBBOICZ-Z080800299	Plates 80x80, 84x84 and Ø98 mm	71x69x50 Screws interaxis 60 mm	4,49
			CBBOICZ-Z115800199	Plates 115x80 and 120x84 mm	97x69x50 Screws interaxis 88 mm	4,84
			CBBOICZ-Z142800199	Plates 142x80 and 144x84 mm	128x69x50 Screws interaxis 117 mm	5,26
			CBBOICZ-Z205800199	Plates 205x80 and 210x84 mm	190x69x50 Screws interaxis 180 mm	6,57
			CBBOICZ-Z267800199	Plates 267x80 mm	252x69x50 Screws interaxis 242 mm	8,67
Kit for back box adaptation in DRY PARTITION		- - -	CBBOICZ-Z0MELKIT99	Plates 80x80, Ø98, 115x80, 142x80, 205x80 and 267x80 mm		1,73
Partition to separate the high and low currents	- - -	- - -	CBAENT-MEL50500099	Plates 142x80, 205x80 and 267x80 mm		0,78
<p>Narrow MELJAC back boxes for CLASSIQUE, ELLIPSE AND VOLUMES collections</p> <p>Designed for narrow plates, they may be used in masonry only and must be sealed.</p>			CBBOICZ-Z091380199	Plates 38x91 mm and doorbell 1920	76x37x45 Screws interaxis 66 mm	4,43
			CBBOICZ-Z133380199	Plates 38x133 mm	118x37x45 Screws interaxis 108 mm	4,58
			CBBOICZ-Z175380199	Plates 38x175 mm	160x37x45 Screws interaxis 150 mm	4,73
Extension pieces for back boxes	- - -		CBBMELB-MEL080REH	Plates 80x80 mm		4,49
	- - -		CBBMELB-MEL115REH	Plates 115x80 mm		4,49
	- - -		CBBMELB-MEL142REH	Plates 142x80 mm		4,49
	- - -		CBBMELB-MEL205REH	Plates 205x80 mm		4,33
	- - -		CBBMELB-MEL267REH	Plates 267x80 mm		4,33

L : length

W : width

D : depth

Prices 04/25 in euros
without VAT

BACK BOXES

Type of back box	Back box overview	Back box colour	Reference	Compatible with...	Overall dimensions (L. x W. x D. in mm)	Price
Back boxes for VOLUMES and CANNELÉE collections LEGRAND 80051, for dry partition only. LEGRAND 80052, for dry partition only. LEGRAND 89246, for masonry only, must be sealed.			CBBBOIL-8005100099	Oval, hexagonal and octagonal plates, Skate, Palet Plates 80x80 of the Cannelée collection	Ø 67xP.50 mm	2,85
			CBBBOIL-8005200099	Plates 151x80 of the Cannelée collection	Ø 2x67 xP.50 mm	12,00
			CBBBOIL-8924600099	Plates Ø 56 mm and 56x56 mm, Macaroons, 1930, 1951, Dome, square and rectangular bell blocks	Ø 47xP.40 mm	8,46
Water-resistant MELJAC back boxes with installation template for SOL collection To install the products with water-resistant cover, installation templates corresponding to the final dimensions of the plates are provided. They are mounted on back boxes for masonry only and must be sealed. The templates allow perfect placement of the back box so that the plate lies flush with the floor.			CBBOISZ-Z10D100199 CBBOISZ-Z14D100199	Plates Ø 100x10 mm Plates Ø 100x14 mm	Ø 100x60 Ø 100x64	6,93
			CBBOISZ-Z10L100199 CBBOISZ-Z14L100199	Plates 100x100x10 mm Plates 100x100x14 mm	100x100x60 100x100x64	6,93
			CBBOISZ-Z10L180199 CBBOISZ-Z14L180199	Plates 180x100x10 mm Plates 180x100x14 mm	180x100x60 180x100x64	10,48
			CBBOISZ-Z10L180299 CBBOISZ-Z14L180299	Plates 180x200x10 mm Plates 180x200x14 mm	180x200x60 180x200x64	20,98

Renovation

Some models of CLASSIQUE and ELLIPSE collections are compatible with the existing standard back boxes (please contact us). MELJAC also proposes bespoke products for an installation on other back boxes.

Prices 04/25 in euros
without VAT

NON-VISIBLE SCREWS OPTION

The screwless option adds a supplement corresponding to the price of the backplate that needs to be fixed to the back box.
This option is only available for the CLASSIQUE and ELLIPSE collections. It is not available for the other brass collections which are already screwless (DAMIER, ELLIOT, CANNELEE, SOL and VOLUMES) or for the collections made of other materials (PIERROT, PLEXIGLASS and LIMOGES).

Type of back box	Compatible with...	Reference	Cold finishes	Warm finishes	Special finishes	Shiny Gilding
Mounting plates for MELJAC back boxes	Plates 80x80	AA3008Z-Z0001MOD	27,30	28,67	32,76	39,31
	Plates 80x115	AA3000Z-Z0001MOD	27,30	28,67	32,76	39,31
	Plates 80x142	AA3002Z-Z0001MOD	33,85	35,54	40,62	48,74
	Plates 205x80	AA3004Z-Z0003MOD	40,40	42,42	48,48	58,18
	Plates 267x80	AA3006Z-Z0004MOD	46,96	49,31	56,35	67,62
	Plates 38x91	- - -	27,30	28,67	32,76	39,31
	Plates 38x133	- - -	27,30	28,67	32,76	39,31
	Plates 38x175	- - -	33,85	35,54	40,62	48,74
Mounting plates for LEGRAND back boxes	Simple	AA3008Z-Z1001MOD	33,85	35,54	40,62	48,74
	Double	AA3025Z-Z0002MOD	44,77	47,01	53,72	64,46
	Triple	AA3031Z-Z0003MOD	55,69	58,47	66,83	80,20
	Quadruple	AA3038Z-Z0004MOD	66,61	69,94	79,93	95,92

*to be added to the price of the plate and back box

Prices 04/25 in euros
without VAT

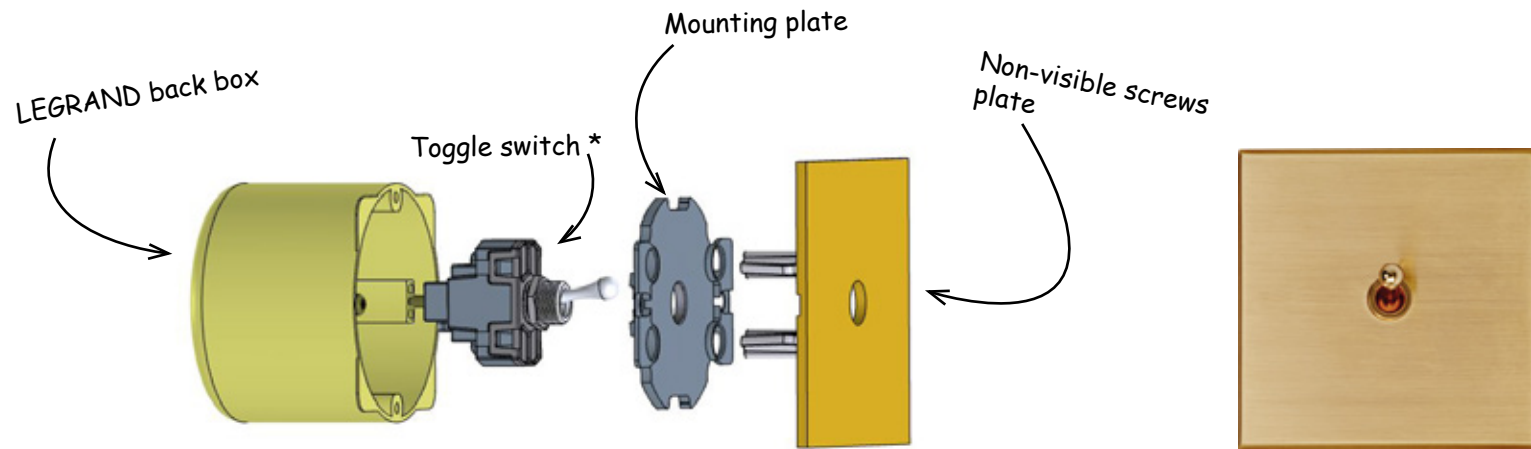
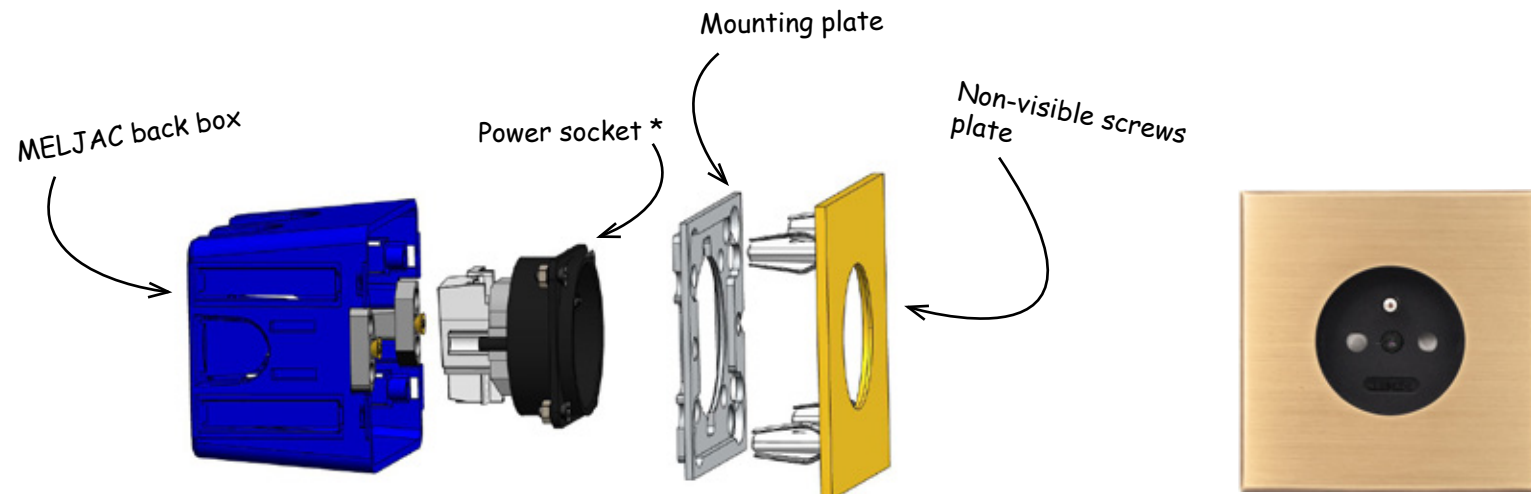

* Example (other mechanisms on demand)

TERMS & CONDITIONS OF SALE

I. MAIN CLAUSE

These General Terms and Conditions apply to all sales of our products, and prevail over any and all other terms and conditions of purchase, unless otherwise expressly agreed and signed in writing by ourselves.

They were updated on 1 October 2022, supersede the previous Terms and Conditions of a prior date and may be changed without prior notice.

II. CONFIDENTIALITY

All designs, plans, drawings or documents which are provided or sent by MELJAC remain the property of same; in any case and for any reason, they may not be disclosed to third parties, under penalty of damages.

III. CONTRACT FORMATION

An order may only be registered and give rise to a MELJAC purchase order if:

- (i) It occurs subsequent to the issuance of a quotation: it must be approved by returning it to the MELJAC sales department dated, signed and marked “good for agreement” (mandatory for private customers). Our quotations are valid for 2 months from date of issue.
- (ii) It is duly written in the form of a Purchase Order on letterhead for companies, with the name and signature of the requester.
- (iii) All items necessary for production have been supplied to the MELJAC sales department:
 - a. Feasibility and diagrams of engraving dated and signed with the words “good for agreement” appearing thereon
 - b. Equipment to be adorned in the case of an order for a plate as casing for equipment not supplied by MELJAC

Manufacturing lead times run only from the time when points (i), (ii) and (iii) are observed and the order is accepted by MELJAC.

This order implies acceptance of the prices in effect on the order date, and the terms of any rebate or trade discount granted.

For any order giving rise to a production order, **no change or cancellation** may be made **after 48 hours**. Within this time span we accept only 2 changes to the same order, which corresponds to one change every 24 hours.

After 48 hours of issuance of the initial order, no change or cancellation may be considered and a new quotation will need to be approved prior to conversion into a **new order**. This new order will naturally be reintegrated into the production priorities as of the new order date.

Similarly, no goods may be returned unless specifically agreed with the person in charge of the commercial offer.

IV. DELIVERY

Owing to the craftsmanship involved in manufacturing the order, the average lead times are provided for general guidance purposes only and may not constitute a binding contractual agreement: a minimum of between 6 and 8 weeks for standard equipment in certain collections (Classique collection); special equipment will be assessed on a case by case basis. Quotations provide an approximate shipping date in weeks and this date may be confirmed or reviewed when the purchase order is sent.

We use our best endeavours to meet the shipping dates indicated. Any delays do not entitle the buyer to cancel the sale, refuse the goods, or claim damages. In any event, we may not be held liable:

- (i) If the payment terms specified are not adhered to
- (ii) If information necessary for the execution of orders is not provided to us in good time
- (iii) In the event of a delay by our own suppliers, unforeseen events, etc.

In such conditions, no penalty for late shipment may be accepted by MELJAC, except in specific cases and subject to prior written agreement.

TERMS & CONDITIONS OF SALE

V. RETENTION OF TITLE

MELJAC retains ownership of goods sold until effective payment of the full price in principal and accessories.

Failure to pay any one of the instalments may lead to repossession of the goods concerned by MELJAC. After 6 months from order execution and the first reminder to pay the remaining balance on the order, MELJAC shall proceed with order cancellation, reintegration (where possible) of the products/components to stocks and shall retain the deposit already paid by way of compensation.

VI. PRICES – TERMS OF PAYMENT

The prices set by MELJAC are exclusive of VAT and in euro; their term of validity is clearly indicated.

Shipping fees are not included in the price (prices are quoted EXW (ICC INCOTERMS 2000): Ex Works).

MELJAC reserves the right to amend them without notice at any time, in particular due to raw material price fluctuation.

An initial minimum payment of 30% of the full order price will apply for all firm orders placed. Payment will be 100% of the full order price in the case of orders equal to or under 500 euro including VAT.

Payment of the remaining balance shall be made before order shipment or collection, according to the shipping terms specified on order confirmation.

Any other payment terms shall be mentioned beforehand on a contractual document issued by MELJAC and signed by the client. In the event of any change to the legal or financial situation of the client, we reserve the right, even after partial execution of the order, to require guarantees to continue its execution.

The terms of payment shall be endorsed and accepted when the order is placed, including payment of the deposit, under penalty of delaying order registration.

Any delay in the settlement of a previous order may halt any new order or suspend any existing order until complete settlement of the requester's account, without prejudice to any other course of action.

In the event of postponed shipment through the client's fault, storage charges may be invoiced.

VII. GUARANTEE

MELJAC's guarantee covers its products against any defect in design, material and/or workmanship for a period of 24 months under the following conditions:

- Any apparent defect must imperatively be reported to MELJAC upon receipt of the goods;
- Any malfunction must be revealed or be reported to MELJAC within a maximum period of 7 days as from shipment, it being specified that the product must be used in accordance with its intended purpose and nature.

Upon expiry of the above periods, the buyer shall no longer be entitled to enforce the guarantee. This period of 24 months runs from the shipment date.

The client shall be required to inform MELJAC by providing explanations about the defect encountered, illustrated with photos. MELJAC may, if necessary, request that the product in question be returned to its premises for inspection.

It is understood that the above guarantee is excluded in the following cases:

- (i) in the event of installation that does not comply with professional standards and practices or the technical instructions (where such instructions exist), and in the event of abnormal, improper or inappropriate use of the product given its nature and/or contractual purpose;
- (ii) in the event, after shipment, of lack of/defective storage and/or misstorage, maintenance, conservation or custody required by the nature and/or contractual purpose of the product, in particular climatic conditions, hydrometric conditions, temperature, light, poorly protected warehouse (this list is not limitative).

The client also acknowledges being informed that surface treatments are likely to change over time according to the conditions referred to in subparagraph (ii) above. **Such potential changes are not guaranteed.**

TERMS & CONDITIONS OF SALE

MELJAC's liability is expressly limited to the guarantees and reservations defined above and may under no circumstances be sought or engaged due to incidents and/or accidents caused to people or items in the event of abnormal installation and/or use or installation or use that is ill-suited to the purpose or nature of our products. Our liability is in any event financially limited to the amount (VAT excluded) of the product(s) or materials under investigation.

The above contractual guarantee shall in no way be construed as limiting the French legal guarantees.

VIII. RESOLUTIVE CLAUSE

In the event of non-execution of their obligations by either party, the contract governed by these General Terms and Conditions of Sale shall be terminated ipso jure to the benefit of the other party, without prejudice or damages that might be claimed by the defaulting party.

Termination shall take effect 15 days after written notice thereof has been sent by registered post with acknowledgement of receipt and remains unsuccessful.

IX. ATTRIBUTION OF JURISDICTION

Any dispute regarding the conclusion, execution or interpretation of the contract and sales which could not be resolved amicably shall be referred to the exclusive jurisdiction of the Commercial Court of Paris, which is expressly granted jurisdiction.

X. ACCEPTANCE AND OBJECTION

The present General Terms and Conditions of Sale constitute an element of contract.

MELJAC clients shall be deemed to have accepted such Terms and Conditions unless reservations are made at the time of the order.



Showroom & Headquarter

3 rue de la Procession
75015 PARIS
FRANCE

☎ : +33 (0)1 40 61 08 43
📠 : +33 (0)1 40 61 08 46
✉ : france@meljac.com

Showroom Rhone-Alpes Region

5 rue Charles DULLIN
69002 LYON
FRANCE

☎ : +33 (0)4 78 38 37 72
📠 : +33 (0)4 78 38 09 64
✉ : lyon@meljac.com

Export Department

☎ : +33 (0)1 47 34 21 42
📠 : +33 (0)1 47 34 21 46
✉ : export@meljac.com

Other services

☎ : +33 (0)1 70 08 06 30
✉ : yachting@meljac.com
✉ : hospitality@meljac.com

Distributed by:

www.meljac.com



@maisonmeljac