

M E L J A C 

PRICE LIST IN EUROS (€)

2023

Valid from 03/1/2023 to 03/31/2024

Due to the current increase in raw materials, MELJAC reserves the right to modify, without notice, the period of validity of its prices. Please contact us.

www.meljac.com



CLASSIQUE

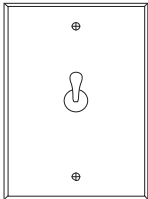

p. 2

ELLIPSE

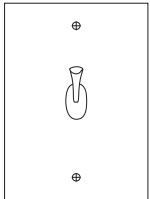

p. 19

DAMIER

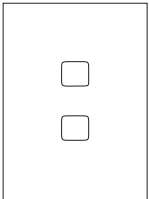

p. 26

CANNELÉE

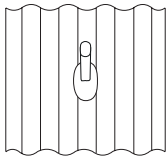

p. 28

SOLARIS



p. 31

TOURNAIRE

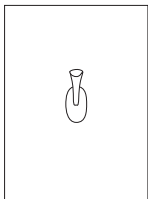

p. 35

SOL

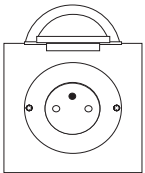

p. 37

VOLUMES

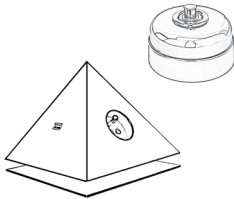

p. 40

PIERROT



p. 45

PLEXIGLASS



p. 47

LIMOGES

CLASSIQUE
ELLIPSE

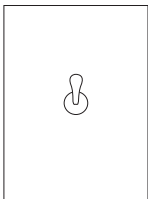

p. 49

CRESTRON CONNECTED

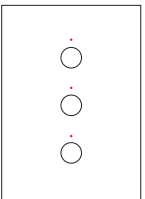

p. 53

SPOTS

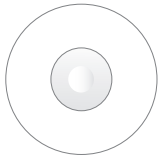

p. 55

TECHNICAL INFORMATION

Materials & finishes
General
Options

Mecanisms
Back boxes
Screwless system

p. 57

p. 63

TERMS & CONDITIONS OF SALE

p. 71

Characteristics of the collections

	Materials and thickness														
	Controls elements				Brass			Glass	Plexiglass	Porcelain	Edges			Screws	
	V&V	Inv auto	BP	BPE	3mm	5,5mm	6mm	4mm	3mm	3mm	Chamfer	Straight	Special	With screws	Screwless
Classique	✓	✓	✓	✓	✓						✓	UR	UR	✓	Option
Ellipse	✓	✓	✓		✓						UR	✓	UR	✓	Option
Damier			✓		✓						UR	✓	UR	UR	✓
Cannelée	✓	✓	✓			✓							✓		✓
Solaris	✓	✓	✓		✓								✓		✓
Tournaire	✓	✓	✓				✓						✓		✓
Sol							✓					✓			✓
Pierrot	✓	✓	✓	✓				✓			✓			✓	
Plexiglass	✓	✓	✓	✓					✓		✓			✓	
Limoges Classique	✓	✓	✓	✓						✓		✓			✓

UR : upon request

CLASSIQUE COLLECTION

SPECIFICATIONS

General

- Switches, reading lamps and sockets
- Protection index: IP20 (*IP21 on request*)
- Products must be installed indoors and earthed (*except for low current*)
- Cleaning only with a soft and dry duster, no product

Covering plate

- Solid brass 3mm thick (*except for shaver socket*)
- With chamfer and visible screws (*except for shaver socket*)
- **Screwless option available for some models – please contact us. Prices for backplates – p. 70**
- Finishes: Nickel, Chrome, Bronze médaille, Cuivre, Doré, Canon de fusil... (*p.57*)

Control mechanisms

- Round base - Droplet lever or push button
- Chrome-plated on cold and special finishes, golden on warm finishes
- Automatic connection by default, screw connection on request

SIZES & BACK BOXES

Sizes (in mm)	Recommended back boxes
Ø98 - 80x80 - 115x80 - 142x80 205x80 - 267x80	Mixed MELJAC, for dry partition and masonry
38x91 - 38x133 - 38x175	Narrow MELJAC, for masonry only
56x56 - Ø56	LEGRAND 89246, for masonry only
Oval - Hexagonal - Octagonal	LEGRAND 80051, for dry partition only

Can be adapted for other retail boxes: please contact us

How to fix?

The covering plate is directly screwed onto the back box.

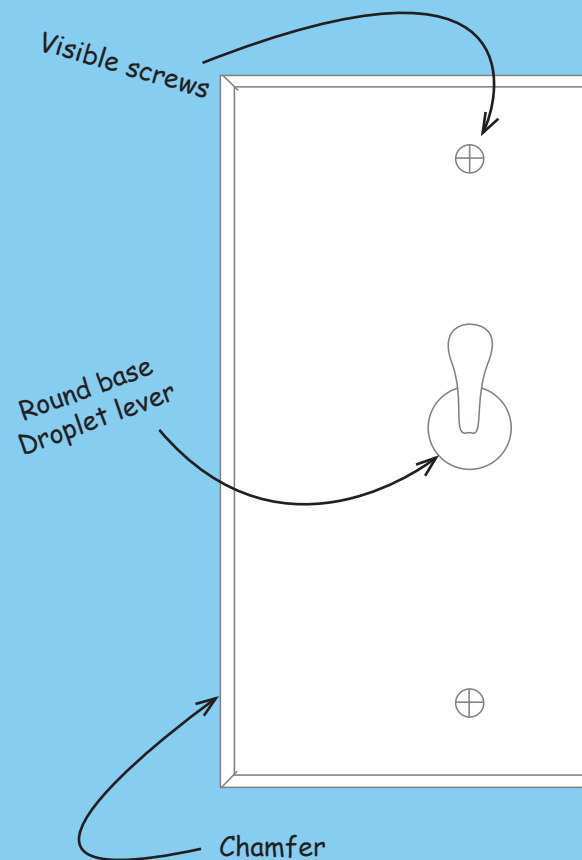

ORIGINE
FRANCE®
GARANTIE

BVCert. 6012053

CLASSIQUE

Diagrams	Back box colour	Size (mm)	Fittings	Reference	Cold finishes	Warm finishes	Special finishes	*Attention Polished Brass See ERRATUM Page 57
		80x80x3	1 control element 2 control elements	FC3008A-A1100010 FC3008A-A1100021	88,80 110,02	93,24 115,52	106,56 132,02	
		80x80x3	1 Electronic Dimmer NU3516 1 Universal Dimmer S520519	FC3008A-K1000023 FC3008A-K1000022	288,46 224,36	302,88 235,58	346,15 269,23	
		80x80x3	Ambiant thermostat Legrand 76720 Ambiant thermostat Legrand 76720 with heat/cold selector	FC3008A-K1000120 FC3008A-K1000124	514,42	540,14	617,30	
		80x80x3	Floor thermostat Schneider S520507 Thermostat Schneider S520509	FC3008A-K1000126 FC3008A-K1000127				417,29 441,67

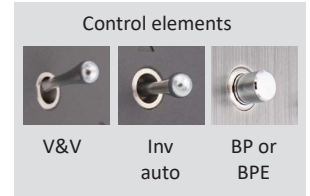

Control elements examples with options

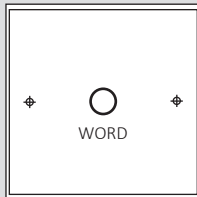

Fittings	Reference	Price from
1 BP	FC3008A-A1100010	88,80
Engraving 1 word	FZ9999Z-ZGR0001M99	+ 16,00

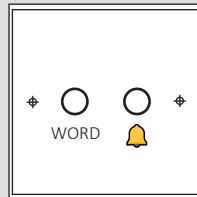

Fittings	Reference	Price from
2 BP	FC3008A-A1100021	110,02
Engraving 1 word	FZ9999Z-ZGR0001M99	+ 16,00
Engraving 1 additional symbol	FZ9999Z-ZGR1001S99	+ 6,00

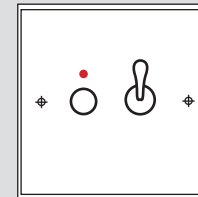

Fittings	Reference	Price from
1 BP + 1 V&V	FC3008A-A1100021	110,02
1 LED indicator	FZLED1Z-Z00D301299	+ 15,66



80x80x3

Balisage asymétrique 2700k-chaud
Balisage asymétrique 4000k-froid

FC3008C-K1002260
FC3008C-K1002261









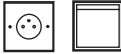

183,01

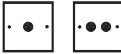
192,16

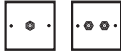
219,61

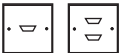









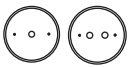



Prices 03/23 in euros
without VAT

CLASSIQUE

Diagrams	Back box colour	Size (mm)	Fittings	Reference	Cold finishes	Warm finishes	Special finishes	*Attention Polished Brass See ERRATUM Page 57
	●	80x80x3	Blank	FC3008A-B0000000	67,58	70,96	81,10	
	●	80x80x3	1 PC 2x10/16A+T	FC3008A-B0000010	91,15	95,71	109,38	
	●	80x80x3	1 PC + Cover	FC3008A-F0000010	194,30	204,02	233,16	
	●	80x80x3	1 universal PC Wonpro	FC3008A-W5000010	100,95	106,00	121,14	
	●	80x80x3	1 universal PC Wonpro + Cover	FC3008A-F5000010	204,10	214,31	244,92	
	●	80x80x3	1 DIN base	FC3008A-B0001621	85,71	90,00	102,85	
	●	80x80x3	2 DIN bases	FC3008A-B0001631	103,85	109,04	124,62	
	●	80x80x3	1 Speaker	FC3008A-B0001540	100,18	105,19	120,22	
	●	80x80x3	2 Flush RCA sockets	FC3008A-B0001870	141,16	148,22	169,39	
	●	80x80x3	1 TV outlet	FC3008A-B0001700	77,13	80,99	92,56	
	●	80x80x3	2 TV outlets	FC3008A-B0001710	86,69	91,02	104,03	
	●	80x80x3	1 TV-FM-SAT	FC3008A-B0000570	129,86	136,35	155,83	
	●	80x80x3	1 HDMI	FC3008A-B0001460	108,16	113,57	129,79	
	●	80x80x3	2 HDMI	FC3008A-B0001470	148,74	156,18	178,49	
	●	80x80x3	1 RJ45	FC3008A-B0000730	104,44	109,66	125,33	
	●	80x80x3	2 RJ45	FC3008A-B0000740	141,30	148,37	169,56	
	●	80x80x3	1 A or C USB power	FC3008A-B0001211	164,16	172,37	196,99	
	●	80x80x3	1 double AA, CC or AC USB power	FC3008A-B0001221	170,73	179,27	204,88	
	●	80x80x3	1 A or C USB F/F adaptator	FC3008A-B0001220	106,89	112,23	128,27	
	●	80x80x3	2 AA, CC ou AC USB F/F adaptators	FC3008A-B0001220	146,21	153,52	175,45	
	●	80x80x3	1 Cable outlet	FC3008A-B0001290	74,20	77,91	89,04	
	●	80x80x3	1 Cable lead-out	FC3008A-B0001370	163,27	171,43	195,92	
	●	80x80x3	1 Brush cable lead-out	FC3008A-B0001292	97,06	101,91	116,47	













Prices 03/23 in euros
without VAT

CLASSIQUE

Diagrams	Back box colour	Size (mm)	Fittings	Reference	Cold finishes	Warm finishes	Special finishes	*Attention Polished Brass See ERRATUM Page 57
		Ø98x3	1 control element	FC3009A-A1100010	118,81	124,75	142,57	
			2 control elements	FC3009A-A1100021	140,04	147,04	168,05	
		Ø98x3	Blank	FC3009A-B0000000	97,59	102,47	117,11	
		Ø98x3	1 PC 2x10/16A+T	FC3009A-B0000010	121,16	127,22	145,39	
		Ø98x3	1 DIN base	FC3009A-B0001621	115,72	121,51	138,86	
			2 DIN bases	FC3009A-B0001631	133,86	140,55	160,63	
		Ø98x3	1 Speaker	FC3009A-B0001540	130,19	136,70	156,23	
		Ø98x3	2 Flush RCA sockets	FC3009A-B0001870	171,18	179,74	205,42	
		Ø98x3	1 TV outlet	FC3009A-B0001700	107,14	112,50	128,57	
			2 TV outlets	FC3009A-B0001710	116,70	122,54	140,04	
		Ø98x3	1 TV-FM-SAT	FC3009A-B0000570	159,88	167,87	191,86	
		Ø98x3	1 HDMI	FC3009A-B0001460	138,17	145,08	165,80	
		Ø98x3	1 RJ45	FC3009A-B0000730	134,45	141,17	161,34	
			2 RJ45	FC3009A-B0000740	171,31	179,88	205,57	
		Ø98x3	1 A or C USB power	FC3009A-B0001211	194,17	203,88	233,00	
	1 double AA, CC or AC USB power		FC3009A-B0001221	200,74	210,78	240,89		
	Ø98x3	1 Cable outlet	FC3009A-B0001290	104,21	109,42	125,05		
		1 Cable lead-out	FC3009A-B0001370	193,29	202,95	231,95		

Prices 03/23 in euros
without VAT

CLASSIQUE

Diagrams	Back box colour	Size (mm)	Fittings	Reference	Cold finishes	Warm finishes	Special finishes	*Attention Polished Brass See ERRATUM Page 57
		56x56x3	1 V&V or 1 BP (AM)	FC3013A-A1100010	82,33	86,45	98,80	
		Ø56x3	1 V&V or 1 BP (AM)	FC3014A-A1100010	95,61	100,39	114,73	
		Hexagonal shape	1 control element	FC3015A-A1100010	115,35	121,12	138,42	
		Octagonal shape	1 control element	FC3016A-A1100010	115,35	121,12	138,42	
		Oval shape	1 control element	FC3017A-A1100010	115,35	121,12	138,42	
		38x91x3	1 control element	FC3011A-A1100010	88,80	93,24	106,56	
		38x133x3	1 control element 2 control elements	FC3010A-A1100010 FC3010A-A1100020	96,21 117,44	101,02 123,31	115,45 140,93	
		38x175x3	3 control elements	FC3012A-A1100030	158,40	166,32	190,08	

Prices 03/23 in euros
without VAT

CLASSIQUE

Diagrams	Back box colour	Size (mm)	Fittings	Reference	Cold finishes	Warm finishes	Special finishes	*Attention Polished Brass See ERRATUM Page 57
		38x91x3	1 12V-mini BP chromé	FC3011A-K3000070	90,17	94,68	108,20	
			2 12V-mini BP chromé	FC3011A-K3000080	112,76	118,40	135,31	
			3 12V-mini BP chromé	FC3011A-K3000090	135,35	142,12	162,42	
			4 12V-mini BP chromé	FC3011A-K3000100	157,94	165,84	189,53	
		38x133x3	1 12V-mini BP chromé	FC3010A-K3000070	97,58	102,46	117,10	
			2 12V-mini BP chromé	FC3010A-K3000080	120,17	126,18	144,20	
			3 12V-mini BP chromé	FC3010A-K3000090	142,76	149,90	171,31	
			4 12V-mini BP chromé	FC3010A-K3000101	165,35	173,62	198,42	
		38x133x3	5 12V-mini BP chromé	FC3010A-K3000110	187,95	197,35	225,54	
			6 12V-mini BP chromé	FC3010A-K3000120	210,54	221,07	252,65	
			7 12V-mini BP chromé	FC3010A-K3000130	233,13	244,79	279,76	
			8 12V-mini BP chromé	FC3010A-K3000140	255,72	268,51	306,86	
	* See box	Ø8x4,5 mm	Flat caps Rounded cap	FZCAPOZ-K3000010 FZCAPOZ-K3000020	23,77	24,96	28,52	

* For more aesthetics and comfort, flat or rounded caps can be placed on buttons.

Prices 03/23 in euros without VAT

CLASSIQUE

Diagrams	Back box colour	Size (mm)	Fittings	Reference	Cold finishes	Warm finishes	Special finishes	*Attention Polished Brass See ERRATUM Page 57
	●	80x115x3	1 control element	FC3001A-A1100010	96,21	101,02	115,45	
			2 control elements	FC3001A-A1100020	117,44	123,31	140,93	
			3 control elements in triangle	FC3001A-A1100031	138,66	145,59	166,39	
			3 BP or 3 BPE in line	FC3001A-A1100090	138,66	145,59	166,39	
			4 control elements	FC3001A-A1100040	159,89	167,88	191,87	
	●	80x115x3	1 Electronic Dimmer NU3516	FC3001A-K1000023	295,88	310,67	355,06	
			1 Universal Dimmer S520519	FC3001A-K1000022	231,78	243,37	278,14	
	●	80x115x3	1 Motion detector Leg. 67026	FC3001A-K1000132	399,45	419,42	479,34	

Prices 03/23 in euros
without VAT

Control elements examples with options

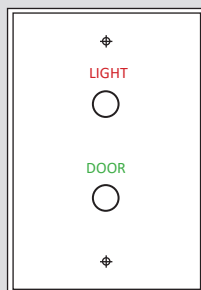



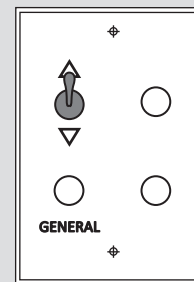



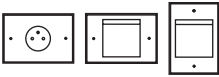

Fittings	Reference	Prices from
2 BP	FC3001A-A1100020	117,44
Light engraving	FZ9999Z-ZGLU000199	+ 88,11
Additional light engraving	FZ9999Z-ZGLU100199	+ 41,33

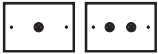

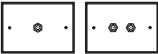



Fittings	Reference	Prices from
1 Inv auto + 3 BP	FC3001A-A1100040	159,89
Engraving 2 triangles	FZ9999Z-ZGR0002T99	+ 16,00
Engraving 1 additional word	FZ9999Z-ZGR1001M99	+ 6,00
Resin engraving	FZ9999Z-ZR00001M99	+ 28,00

CLASSIQUE



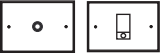



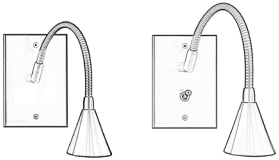

Diagrams	Back box colour	Size (mm)	Fittings	Reference	Cold finishes	Warm finishes	Special finishes	*Attention Polished Brass See ERRATUM Page 57
	●	115x80x3	Blank	FC3000A-B0000000	74,99	78,74	89,99	
	●	115x80x3	1 PC 2x10/16A+T	FC3000A-B0000010	98,57	103,50	118,28	<div style="border: 1px solid gray; padding: 5px; text-align: center;"> Plinth size possible 115x63x3 <i>Contact us</i> </div>
	●	115x80x3	1 PC + Cover (horizontal)	FC3000A-F0000010	201,72	211,81	242,06	
	●	80x115x3	1 PC + Cover (vertical)	FC3001A-F0000010				
	●	115x80x3	1 universal PC Wonpro	FC3000A-W5000010	108,37	113,79	130,04	
	●	115x80x3	1 DIN base	FC3000A-B0001621	93,13	97,79	111,76	
			2 DIN bases	FC3000A-B0001631	111,26	116,82	133,51	
	●	115x80x3	1 Speaker	FC3000A-B0001540	107,60	112,98	129,12	
	●	115x80x3	2 Flush RCA sockets	FC3000A-B0001870	148,58	156,01	178,30	
			3 Flush RCA sockets	FC3000A-B0001880	185,37	194,64	222,44	
	●	115x80x3	1 TV outlet	FC3000A-B0001700	84,55	88,78	101,46	
			2 TV outlets	FC3000A-B0001710	94,10	98,81	112,92	
	●	115x80x3	1 TV-FM-SAT	FC3000A-B0000570	137,28	144,14	164,74	
	●	115x80x3	1 HDMI	FC3000A-B0001460	115,57	121,35	138,68	
	●	115x80x3	1 RJ45	FC3000A-B0000730	111,85	117,44	134,22	
			2 RJ45	FC3000A-B0000740	148,71	156,15	178,45	
	●	115x80x3	1 A or C USB power	FC3000A-B0001211	171,57	180,15	205,88	
			1 double AA, CC or AC USB power	FC3000A-B0001221	178,15	187,06	213,78	
			1 A or C USB F/F adaptor	FC3000A-B0001210	171,57	180,15	205,88	

Prices 03/23 in euros
without VAT

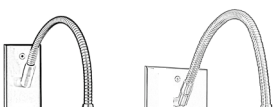
CLASSIQUE

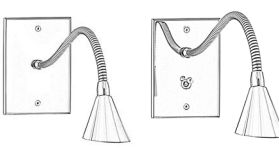
Special plates	Back box colour	Size (mm)	Fittings	Reference	Cold finishes	Warm finishes	Special finishes	*Attention Polished Brass See ERRATUM Page 57	
	●	115x80x3	1 Cable outlet	FC3000A-B0001290	81,61	85,69	97,93		
			1 Cable lead-out	FC3000A-B0001370	170,69	179,22	204,83		
	■	86x160x12	LEGRAND Shaver socket with cover	FC1200A-K1000200	606,54	636,87	727,85		
			X in dry partition:	1 LEGRAND 80052 back box	CBBBOIL-8005200099		10,99		
			X in masonry:	2 LEGRAND 80151 back boxes	CBBBOIL-8015100099		3,71		
	●	115x80x3	Vimar Shaver socket	FC3000A-B1001300	324,01	340,21	388,81		
	●	80x115x3	HAGER key card switch	FC3001A-K1000180	389,70	409,19	467,64		

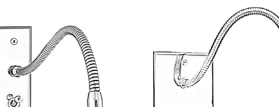
CLASSIQUE





Tulipe reading lamps		Back box colour	Size (mm)	Fittings	Reference	Cold finishes	Warm finishes	Special finishes	*Attention Polished Brass See ERRATUM Page 57	
	●	80x115x3	bend 0° bend 135°	FC3001A-M1000020	368,91	387,36	442,69		Please see technical details from page 53	
				FC3001A-M1000010						
	●	80x115x3	bend 0° + 1 control element bend 135° + 1 control element	FC3001A-M1000080	390,13	409,64	468,16			
				FC3001A-M1000070						
STRAIGHT CONE										
	○	38x133x3	bend 0° + 1 control element bend 135° + 1 control element	FC3010A-M1000080	390,13	409,64	468,16			
				FC3010A-M1000070						
	●	80x115x3	bend 0° + 2 control elements bend 135° + 2 control elements	FC3001A-M1000380	411,36	431,93	493,63			
				FC3001A-M1000370						
	●	80x115x3	bend 0° bend 135°	FC3001A-M1000050	368,91	387,36	442,69			
				FC3001A-M1000040						
	●	80x115x3	bend 0° + 1 control element bend 135° + 1 control element	FC3001A-M1000110	390,13	409,64	468,16			
				FC3001A-M1000100						
BEVELED CONE										
	○	38x133x3	bend 0° + 1 control element bend 135° + 1 control element	FC3010A-M1000110	390,13	409,64	468,16			
				FC3010A-M1000100						
	●	80x115x3	bend 0° + 2 control elements bend 135° + 2 control elements	FC3001A-M1000410	411,36	431,93	493,63			
				FC3001A-M1000400						

Please see technical details from page 53

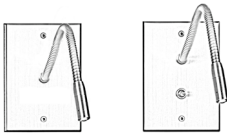
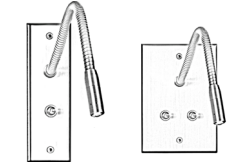
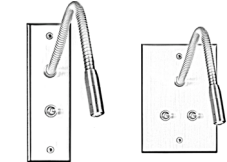
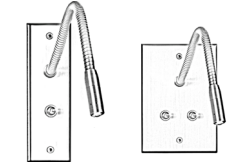

Prices 03/23 in euros without VAT

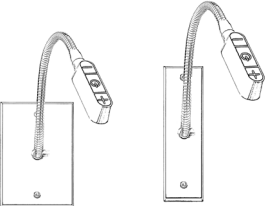
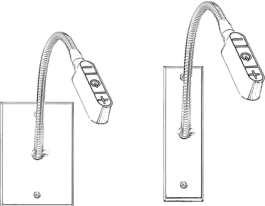
CLASSIQUE

Roseau reading lamps		Back box colour	Size (mm)	Fittings	Reference	Cold finishes	Warm finishes	Special finishes	*Attention Polished Brass See ERRATUM Page 57
	●	80x115x3	bend 0°	FC3001A-M2000020	312,99	328,64	375,59		
			bend 135°	FC3001A-M2000010					
	●	80x115x3	bend 0° + 1 control element	FC3001A-M2000080	334,21	350,92	401,05		
			bend 135° + 1 control element	FC3001A-M2000070					
	○	38x133x3	bend 0° + 1 control element	FC3010A-M2000080	334,21	350,92	401,05		
			bend 135° + 1 control element	FC3010A-M2000070					
	●	80x115x3	bend 0° + 2 control elements	FC3001A-M2000380	355,44	373,21	426,53		
			bend 135° + 2 control elements	FC3001A-M2000370					
<div style="text-align: center;">  <p>Roseau</p> </div>									
<div style="text-align: center;">  <p>Tactile</p> </div>									
Tactile reading lamps									
	●	80x115x3	bend 0° + 1 LED	FC3001A-M3000020	459,91	482,91	551,89		
			bend 135° + 1 LED	FC3001A-M3000010					
	○	38x133x3	bend 0° + 1 LED	FC3010A-M3000020	459,91	482,91	551,89		
			bend 135° + 1 LED	FC3010A-M3000010					
<div style="display: flex; justify-content: space-around; align-items: center;"> <div style="text-align: center;"> <p>Bend 0°</p>  </div> <div style="text-align: center;"> <p>Bend 135°</p>  </div> </div>									







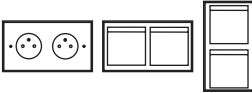
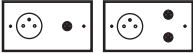

Prices 03/23 in euros
without VAT

CLASSIQUE

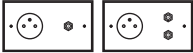
Diagrams	Back box colour	Size (mm)	Fittings	Reference	Cold finishes	Warm finishes	Special finishes	*Attention Polished Brass See ERRATUM Page 57
	●	80x142x3	1 control element	FC3003A-A1100010	115,95	121,75	139,14	
			2 control elements	FC3003A-A1100020	137,18	144,04	164,62	
			3 control elements	FC3003A-A1100030	158,40	166,32	190,08	
			4 control elements	FC3003A-A1100040	179,62	188,60	215,54	
			5 control elements	FC3003A-A1100050	200,85	210,89	241,02	
			6 control elements	FC3003A-A1100060	222,07	233,17	266,48	
	●	80x142x3	1 PC + 1 control element	FC3003A-C0010010	139,53	146,51	167,44	
			1 PC + 2 control elements	FC3003A-C0010020	160,75	168,79	192,90	
	●	80x142x3	1 Var E + 1 control element	FC3003A-K1000311	336,84	353,68	404,21	
			1 Var E + 2 control elements	FC3003A-K1000330	358,06	375,96	429,67	
	●	142x80x3	1 PC + 1 control element	FC3002A-C0010010	139,53	146,51	167,44	
			1 PC + 2 control elements	FC3002A-C0010020	160,75	168,79	192,90	
	●	142x80x3	1 Var E + 1 control element	FC3002A-K1000311	336,84	353,68	404,21	
			1 Var E + 2 control elements	FC3002A-K1000330	358,06	375,96	429,67	

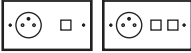

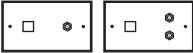

Prices 03/23 in euros
without VAT

CLASSIQUE

Diagrams	Back box colour	Size (mm)	Fittings	Reference	Cold finishes	Warm finishes	Special finishes	*Attention Polished Brass See ERRATUM Page 57
	●	142x80x3	Blank	FC3002A-B0000000	94,73	99,47	113,68	
	●	142x80x3	2 PC 2x10/16A+T	FC3002A-B0000020	141,88	148,97	170,26	<div style="border: 1px solid gray; padding: 5px; text-align: center;"> Plinth size possible 142x63x3 <i>Contact us</i> </div>
	●	142x80x3	2 PC + Covers (horizontal)	FC3002A-F0000020	348,18	365,59	417,82	
	●	80x142x3	2 PC + Covers (vertical)	FC3003A-F0000020				
	●	142x80x3	1 PC + 1 DIN base	FC3002A-B0052640	136,44	143,26	163,73	
	●		1 PC + 2 DIN bases	FC3002A-B0052710	154,58	162,31	185,50	
	●	142x80x3	1 PC + 1 Speaker	FC3002A-B0047320	150,91	158,46	181,09	
	●	142x80x3	1 PC + 1 TV outlet	FC3002A-B0058240	127,86	134,25	153,43	
			1 PC + 2 TV outlets	FC3002A-B0058310	137,41	144,28	164,89	
	●	142x80x3	1 PC + 1 TV-FM-SAT	FC3002A-B0007340	180,59	189,62	216,71	
	●	142x80x3	1 PC + 1 RJ45	FC3002A-B0010640	155,16	162,92	186,19	
			1 PC + 2 RJ45	FC3002A-B0010710	192,02	201,62	230,42	
	●	142x80x3	1 RJ45 + 1 TV-FM-SAT	FC3002A-B0012600	193,88	203,57	232,66	
	●	142x80x3	1 RJ45 + 1 TV outlet	FC3002A-B0060760	141,14	148,20	169,37	
			1 RJ45 + 2 TV outlets	FC3002A-B0060830	150,70	158,24	180,84	
	●	142x80x3	2 RJ45	FC3002A-B0000740	168,45	176,87	202,14	
			3 RJ45	FC3002A-B0000750	205,31	215,58	246,37	
	●	142x80x3	1 PC + 1 A or C USB power	FC3002A-B0028841	214,88	225,62	257,86	
			1 PC + 1 double AA, CC or AC USB power	FC3002A-B0028911	221,46	232,53	265,75	



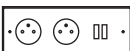
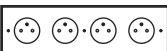



Prices 03/23 in euros
without VAT

CLASSIQUE

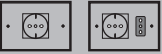
Diagrams	Back box colour	Size (mm)	Fittings	Reference	Cold finishes	Warm finishes	Special finishes	*Attention Polished Brass See ERRATUM Page 57
	●	205x80x3	Blank	FC3004A-B0000000	154,58	162,31	185,50	
	●	205x80x3	3 PC 2x10/16A+T	FC3004A-B0000030	225,31	236,58	270,37	
	●	205x80x3	2 PC + 1 TV outlet	FC3004A-B0058250	211,28	221,84	253,54	
	●	205x80x3	2 PC + 2 TV outlets	FC3004A-B0058320	220,84	231,88	265,01	
	●	205x80x3	2 PC + 1 TV-FM-SAT	FC3004A-B0007350	264,02	277,22	316,82	
	●	205x80x3	1 PC + 1 TV outlet + 1 RJ45	FC3004A-B1631560	224,57	235,80	269,48	
	●	205x80x3	1 PC + 2 TV outlets + 1 RJ45	FC3004A-B1631770	234,12	245,83	280,94	
	●	205x80x3	1 PC + 1 TV-FM-SAT + 1 RJ45	FC3004A-B1051950	277,30	291,17	332,76	
	●	205x80x3	2 PC + 1 RJ45	FC3004A-B0010650	238,59	250,52	286,31	
	●	205x80x3	2 PC + 2 RJ45	FC3004A-B0010720	275,45	289,22	330,54	
	●	205x80x3	1 PC + 1 USB + 1 RJ45	FC3004A-B1074640	311,59	327,17	373,91	
	●	205x80x3	2 PC + 1 Type A USB power	FC3004A-B0028851	298,31	313,23	357,97	
	●	205x80x3	2 PC + 1 double AA, CC or AC USB power	FC3004A-B0028921	304,88	320,12	365,86	
	●	267x80x3	Blank	FC3006A-B0000000	193,62	203,30	232,34	
	●	267x80x3	4 PC 2x10/16A+T	FC3006A-B0000040	287,92	302,32	345,50	
	●	267x80x3	3 PC + 1 TV outlet	FC3006A-B0058260	273,90	287,60	328,68	
	●	267x80x3	3 PC + 2 TV outlets	FC3006A-B0058330	283,46	297,63	340,15	
	●	267x80x3	3 PC + 1 TV-FM-SAT	FC3006A-B0007360	326,64	342,97	391,97	
	●	267x80x3	2 PC + 1 TV outlet + 1 RJ45	FC3006A-B1631571	287,19	301,55	344,63	
	●	267x80x3	2 PC + 2 TV outlets + 1 RJ45	FC3006A-B1631781	296,74	311,58	356,09	
	●	267x80x3	2 PC + 2 RJ45	FC3006A-B0010720	314,49	330,21	377,39	
	●	267x80x3	3 PC + 1 RJ45	FC3006A-B0010660	301,21	316,27	361,45	
	●	267x80x3	3 PC + 2 RJ45	FC3006A-B0010730	338,07	354,97	405,68	

Prices 03/23 in euros
without VAT

CLASSIQUE - EXPORT STANDARD SOCKETS

Diagrams	Back box colour	Size (mm)	Fittings	Reference	Cold finishes	Warm finishes	Special finishes	*Attention Polished Brass See ERRATUM Page 57
	●	115x80x3	1 PC Schuko	FC3000A-B0000250	105,38	110,65	126,46	
		115x80x3	1 PC Schuko + Cover (horizontal)	FC3000A-F0000250	} 208,53	218,96	250,24	
		80x115x3	1 PC Schuko + Cover (vertical)	FC3001A-F0000250				
	●	115x80x3	1 PC Unel (Schuko + Bipasso)	FC3000A-B0000490	136,34	143,16	163,61	
			1 PC Unel + 1 PC Bipasso	FC3000A-B0084980	179,29	188,25	215,15	
	●	115x80x3	1 PC Bipasso	FC3000A-B0000410	117,95	123,85	141,54	
			2 PC Bipasso	FC3000A-B0000420	160,90	168,95	193,08	
			3 PC Bipasso	FC3000A-B0000430	203,86	214,05	244,63	
	●	80x80x3	1 PC Schuko	FC3008A-B0000250	97,97	102,87	117,56	
			1 PC Schuko + Cover	FC3008A-F0000250	201,12	211,18	241,34	
	●	80x80x3	1 PC Unel (Schuko + Bipasso)	FC3008A-B0000490	128,92	135,37	154,70	
	●	80x80x3	1 PC Bipasso	FC3008A-B0000410	110,53	116,06	132,64	
			2 PC Bipasso	FC3008A-B0000420	153,49	161,16	184,19	
	●	Ø98x3	1 PC Schuko	FC3009A-B0000250	127,98	134,38	153,58	
	●	Ø98x3	1 PC Unel (Schuko + Bipasso)	FC3009A-B0000490	158,94	166,89	190,73	
	●	Ø98x3	1 PC Bipasso	FC3009A-B0000410	140,54	147,57	168,65	
			2 PC Bipasso	FC3009A-B0000420	183,50	192,68	220,20	

Prices 03/23 in euros
without VAT

CLASSIQUE - EXPORT STANDARD SOCKETS

Diagrams	Back box colour	Size (mm)	Fittings	Reference	Cold finishes	Warm finishes	Special finishes	*Attention Polished Brass See ERRATUM Page 57
	●	142x80x3	1 PC Schuko + 1 control element	FC3002A-C1610010	146,34	153,66	175,61	
			1 PC Schuko + 2 control elements	FC3002A-C1610020	167,57	175,95	201,08	
	●	80x142x3	1 control element + 1 PC Schuko	FC3003A-C1610010	146,34	153,66	175,61	
			2 control elements + 1 PC Schuko	FC3003A-C1610020	167,57	175,95	201,08	
	●	142x80x3	2 PC Schuko	FC3002A-B0000260	155,51	163,29	186,61	
		142x80x3	2 PC Schuko + Covers (horizontal)	FC3002A-F0000260	} 361,81	379,90	434,17	
		80x142x3	2 PC Schuko + Covers (vertical)	FC3003A-F0000260				
	●	142x80x3	1 PC Schuko + 1 DIN base	FC3002A-B0053480	143,25	150,41	171,90	
			1 PC Schuko + 2 DIN bases	FC3002A-B0053550	161,39	169,46	193,67	
	●	142x80x3	1 PC Schuko + 1 Speaker	FC3002A-B0048160	157,72	165,61	189,26	
	●	142x80x3	1 PC Schuko + 1 TV outlet	FC3002A-B0059080	134,67	141,40	161,60	
			1 PC Schuko + 2 TV outlets	FC3002A-B0059150	144,23	151,44	173,08	
	●	142x80x3	1 PC Schuko + 1 TV-FM-SAT	FC3002A-B0008000	187,41	196,78	224,89	
	●	142x80x3	1 PC Schuko + 1 RJ45	FC3002A-B0011480	161,98	170,08	194,38	
			1 PC Schuko + 2 RJ45	FC3002A-B0011550	198,84	208,78	238,61	
	●	142x80x3	1 PC Schuko + 1 A or C USB power	FC3002A-B0029681	221,70	232,79	266,04	
			1 PC Schuko + 1 double AA, CC or AC USB power	FC3002A-B0029751	228,27	239,68	273,92	
			1 PC Schuko + 1 A or C USB power					
	●	142x80x3	1 PC Unel + 1 PC Bipasso	FC3002A-B0084980	199,03	208,98	238,84	
			1 PC Unel + 2 PC Bipasso	FC3002A-B0085050	241,99	254,09	290,39	

Prices 03/23 in euros
without VAT

CLASSIQUE - EXPORT STANDARD SOCKETS

Diagrams	Back box colour	Size (mm)	Fittings	Reference	Cold finishes	Warm finishes	Special finishes	*Attention Polished Brass See ERRATUM Page 57
		205x80x3	3 PC Schuko	FC3004A-B0000270	245,75	258,04	294,90	
		205x80x3	2 PC Schuko + 1 TV outlet	FC3004A-B0059090	224,91	236,16	269,89	
			2 PC Schuko + 2 TV outlets	FC3004A-B0059160	234,47	246,19	281,36	
		205x80x3	2 PC Schuko + 1 TV-FM-SAT	FC3004A-B0008010	277,65	291,53	333,18	
		205x80x3	1 PC Schuko + 1 TV outlet + 1 RJ45	FC3004A-B1633240	231,38	242,95	277,66	
			1 PC Schuko + 2 TV outlets + 1 RJ45	FC3004A-B1633450	240,94	252,99	289,13	
		205x80x3	1 PC Schuko + 1 TV-FM-SAT + 1 RJ45	FC3004A-B1053510	284,12	298,33	340,94	
		205x80x3	2 PC Schuko + 1 RJ45	FC3004A-B0011490	252,22	264,83	302,66	
	2 PC Schuko + 2 RJ45		FC3004A-B0011560	289,08	303,53	346,90		
	205x80x3	2 PC Schuko + 1 Type A USB power	FC3004A-B0029691	311,94	327,54	374,33		
		2 PC Schuko + 1 double Type A USB power	FC3004A-B0029761	318,51	334,44	382,21		
		267x80x3	4 PC Schuko	FC3006A-B0000280	315,18	330,94	378,22	
		267x80x3	3 PC Schuko + 1 TV outlet	FC3006A-B0059100	294,35	309,07	353,22	
			3 PC Schuko + 2 TV outlets	FC3006A-B0059170	303,90	319,10	364,68	
		267x80x3	3 PC Schuko + 1 TV-FM-SAT	FC3006A-B0008020	347,08	364,43	416,50	
		267x80x3	2 PC Schuko + 1 TV outlet + 1 RJ45	FC3006A-B1633250	300,82	315,86	360,98	
			2 PC Schuko + 2 TV outlets + 1 RJ45	FC3006A-B1633460	310,37	325,89	372,44	
		267x80x3	2 PC Schuko + 2 RJ45	FC3006A-B0011560	328,12	344,53	393,74	
			3 PC Schuko + 1 RJ45	FC3006A-B0011500	321,65	337,73	385,98	
	3 PC Schuko + 2 RJ45		FC3006A-B0011570	358,51	376,44	430,21		

Prices 03/23 in euros
without VAT

ELLIPSE COLLECTION

SPECIFICATIONS

General

- Switches, reading lamps and sockets
- Protection index: IP20 (*IP21 on request*)
- Products must be installed indoors and earthed
- Cleaning only with a soft and dry duster, no product

Covering plate

- Solid brass 3mm thick
- With straight edges and visible screws
- **Screwless option available for some models – please contact us. Prices for backplates – p. 70**
- Finishes: Nickel, Chrome, Bronze médaille, Cuivre, Doré, Canon de fusil... (p.57)

Control mechanisms

- Elongated base - Ellipse, Seattle or JMA lever (with additional charge) and lighting option or oblong push button
- Chrome-plated on cold and special finishes, golden on warm finishes
- Automatic connection by default, screw connection on request

SIZES & BACK BOXES

Sizes (in mm)	Recommended back boxes
Ø98 - 80x80 - 115x80 - 142x80	Mixed MELJAC, for dry partition and masonry
38x133	Narrow MELJAC, for masonry only

Can be adapted for other retail boxes: please contact us





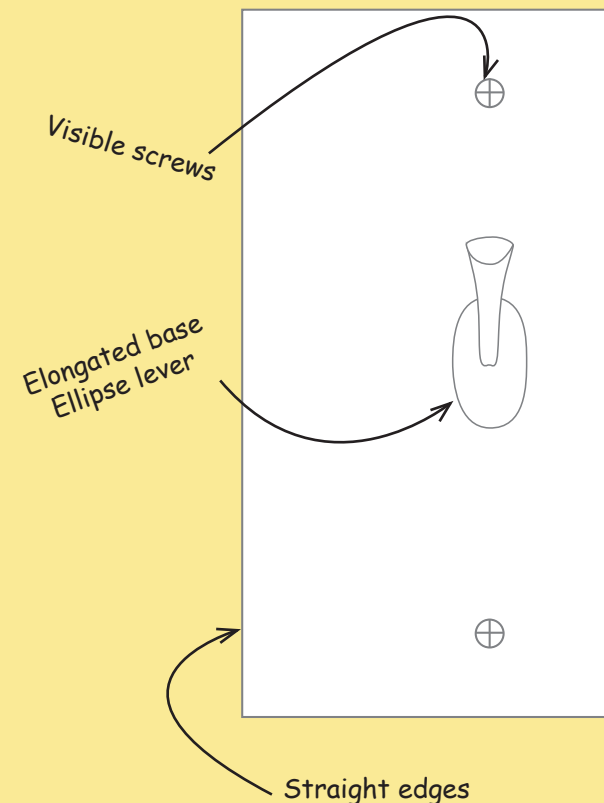

How to fix?

The covering plate is directly screwed onto the back box.



BVCert. 6012053

ELLIPSE

Diagrams	Back box colour	Size (mm)	Fittings	Reference	Cold finishes	Warm finishes	Special finishes	*Attention Polished Brass See ERRATUM Page 57
		80x80x3	1 control element	FE3008B-A1100010	127,14	133,50	152,57	<div style="border: 1px solid black; padding: 5px;"> <p style="text-align: center;">Control elements</p>    <p style="text-align: center;">V&V Inv auto BP</p> </div>
			2 control elements	FE3008B-A1100021	186,70	196,04	224,04	
		Ø98x3	1 control element	FE3009B-A1100010	157,15	165,01	188,58	
			2 control elements	FE3009B-A1100021	216,71	227,55	260,05	

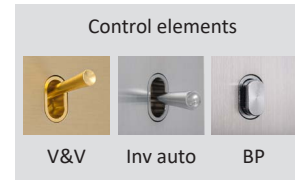

Prices for Ellipse and Seattle toggles only



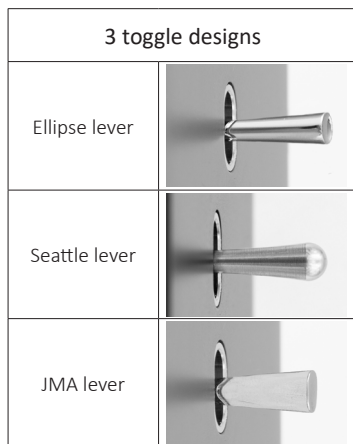



JMA lever: 26 € additional charge

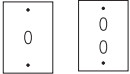

	Additional charges				
	Fittings		Bespoke options		
	Gold or chrome standard version	Chromé vif or gilding	Other color chart finishes	Polished mirror effect	Backlit
Ellipse lever	✓		✓ from 16,00	OR ✓ + 36,00	+ + 19,79
Seattle lever	✓		✓ from 16,00	OR ✓ + 36,00	+ + 19,79
JMA lever	X	X	✓ + 26,00	X	X









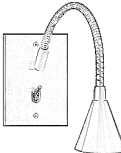
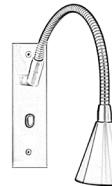
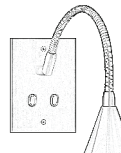

Prices 03/23 in euros
without VAT

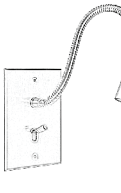
ELLIPSE

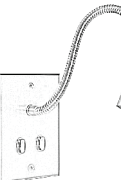
Diagrams	Back box colour	Size (mm)	Fittings	Reference	Cold finishes	Warm finishes	Special finishes	*Attention Polished Brass See ERRATUM Page 57
	●	80x115x3	1 control element	FE3001B-A1100010	134,55	141,28	161,46	
			2 control elements	FE3001B-A1100020	194,11	203,82	232,93	
	●	80x115x3	3 control elements in triangle	FE3001B-A1100031	253,67	266,35	304,40	
	●	80x115x3	4 control elements	FE3001B-A1100040	313,23	328,89	375,88	
	●	38x91x3	1 control element	FE3011B-A1100010	127,14	133,50	152,57	
	○	38x133x3	1 control element	FE3010B-A1100010	134,55	141,28	161,46	
			2 control elements	FE3010B-A1100020	194,11	203,82	232,93	
	●	38x175x3	3 control elements	FE3012B-A1100030	273,41	287,08	328,09	

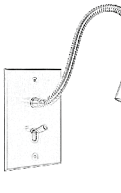
Prices 03/23 in euros
without VAT

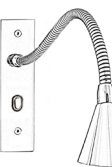
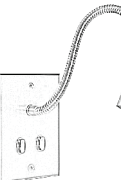
ELLIPSE

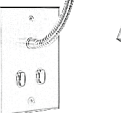
Tulipe reading lamps		Back box colour	Size (mm)	Fittings	Reference	Cold finishes	Warm finishes	Special finishes	*Attention Polished Brass See ERRATUM Page 57
 	●	80x115x3	bend 0°	FE3001B-M1000020	368,91	387,36	442,69	Please see technical details from page 53	
			bend 135°	FE3001B-M1000010					
 	●	80x115x3	bend 0° + 1 control element	FE3001B-M1000080	428,47	449,89	514,16		
			bend 135° + 1 control element	FE3001B-M1000070					
 	○	38x133x3	bend 0° + 1 control element	FE3010B-M1000080	428,47	449,89	514,16		
			bend 135° + 1 control element	FE3010B-M1000070					
 	●	80x115x3	bend 0° + 2 control elements	FE3001B-M1000380	488,03	512,43	585,64		
			bend 135° + 2 control elements	FE3001B-M1000370					
 	●	80x115x3	bend 0°	FE3001B-M1000050	368,91	387,36	442,69		
			bend 135°	FE3001B-M1000040					
 	●	80x115x3	bend 0° + 1 control element	FE3001B-M1000110	428,47	449,89	514,16		
			bend 135° + 1 control element	FE3001B-M1000100					
 	○	38x133x3	bend 0° + 1 control element	FE3010B-M1000110	428,47	449,89	514,16		
			bend 135° + 1 control element	FE3010B-M1000100					
 	●	80x115x3	bend 0° + 2 control elements	FE3001B-M1000410	488,03	512,43	585,64		
			bend 135° + 2 control elements	FE3001B-M1000400					

Tulipe straight cone





Tulipe beveled cone

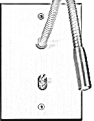

Prices 03/23 in euros
without VAT

ELLIPSE

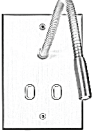
Roseau reading lamps		Back box colour	Size (mm)	Fittings	Reference	Cold finishes	Warm finishes	Special finishes	*Attention Polished Brass See ERRATUM Page 57
 	●	80x115x3	bend 0°	FE3001B-M2000020	312,99	328,64	375,59		
			bend 135°	FE3001B-M2000010					
	●	80x115x3	bend 0° + 1 control element	FE3001B-M2000080	372,55	391,18	447,06		
			bend 135° + 1 control element	FE3001B-M2000070					
 	○	38x133x3	bend 0° + 1 control element	FE3010B-M2000080	372,55	391,18	447,06		
			bend 135° + 1 control element	FE3010B-M2000070					
	●	80x115x3	bend 0° + 2 control elements	FE3001B-M2000380	432,11	453,72	518,53		
			bend 135° + 2 control elements	FE3001B-M2000370					

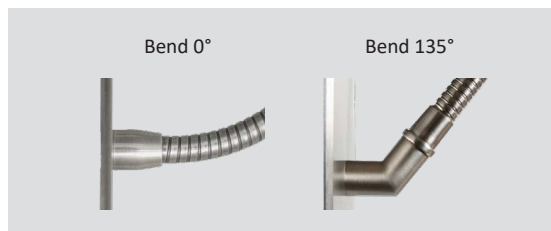





Prices 03/23 in euros
without VAT

ELLIPSE

Diagrams	Back box colour	Size (mm)	Fittings	Reference	Cold finishes	Warm finishes	Special finishes	*Attention Polished Brass See ERRATUM Page 57
	●	80x142x3	3 control elements	FE3003B-A1100030	273,41	287,08	328,09	
	●	80x142x3	4 control elements	FE3003B-A1100040	332,97	349,62	399,56	
	●	80x142x3	5 control elements	FE3003B-A1100050	392,53	412,16	471,04	
	●	80x142x3	6 control elements	FE3003B-A1100060	452,09	474,69	542,51	
	●	80x142x3	1 control element + 1 PC	FE3003B-C0010010	177,86	186,75	213,43	
	●	80x142x3	2 control elements + 1 PC	FE3003B-C0010020	237,43	249,30	284,92	
	●	80x142x3	1 control element + Var E	FE3003B-K1000311	375,17	393,93	450,20	
	●	80x142x3	2 control elements + 1 Var E	FE3003B-K1000330	358,06	375,96	429,67	
	●	142x80x3	1 PC + 1 control element	FE3002B-C0010010	177,86	186,75	213,43	
	●	142x80x3	1 PC + 2 control elements	FE3002B-C0010020	237,43	249,30	284,92	
	●	142x80x3	1 Var E + 1 control element	FE3002B-K1000311	375,17	393,93	450,20	
	●	142x80x3	1 Var E + 2 control elements	FE3002B-K1000330	434,73	456,47	521,68	

Prices 03/23 in euros
without VAT

ELLIPSE - EXPORT STANDARD SOCKETS

Diagrams	Back box colour	Size (mm)	Fittings	Reference	Cold finishes	Warm finishes	Special finishes	*Attention Polished Brass See ERRATUM Page 57
	●	142x80x3	1 PC Schuko + 1 control element	FE3002B-C1610010	184,68	193,91	221,62	
	●	142x80x3	1 PC Schuko + 2 control elements	FE3002B-C1610020	244,24	256,45	293,09	
	●	80x142x3	1 control element + 1 PC Schuko	FE3003B-C1610010	184,68	193,91	221,62	
	●	80x142x3	2 control elements + 1 PC Schuko	FE3003B-C1610020	244,24	256,45	293,09	

Prices 03/23 in euros
without VAT

DAMIER COLLECTION

SPECIFICATIONS

General

- Collection designed for low voltage 12V currents (home automation) and adaptable to high voltage 230V upon request
- Protection index: IP20 (IP21 on request)
- Products must be installed indoors and earthed
- Cleaning only with a soft and dry duster, no product

Covering plate

- Solid brass 3mm thick
- *With straight edges and non-visible screws (possible with visible screws: contact us)*
- *Finishes: Nickel, Chrome, Bronze médaille, Cuivre, Doré, Canon de fusil... (p.57)*

Control mechanisms

- Square push button 14x14mm in relief or flush
- Other button shapes possible (round, oval, triangular, rectangular...)
- In the same finish as the covering plate
- Screw connection

SIZES & BACK BOXES

Sizes (in mm)	Back box
80x80 - 115x80 - 142x80	Mixed MELJAC, for dry partition and masonry

How to fix?

The mounting plate with mechanisms screws directly onto the back box.
The covering plate snaps onto the mounting plate.

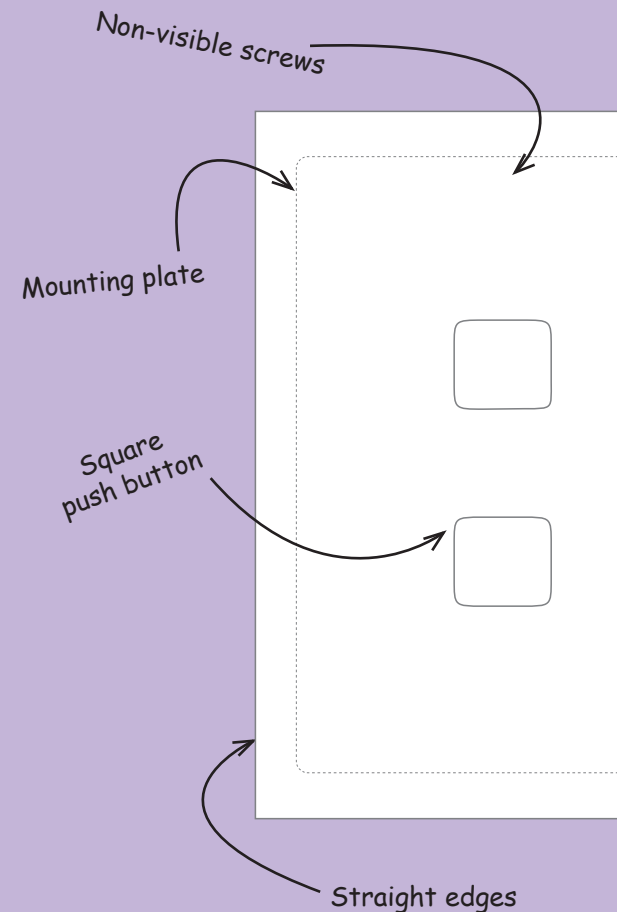
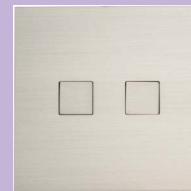

BVCert. 6012053

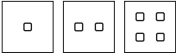
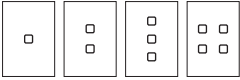
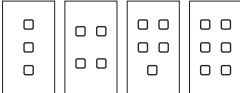
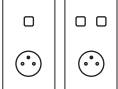
Diagrams	Back box colour	Size (mm)	Fittings	Reference	Cold finishes	Warm finishes	Special finishes	*Attention Polished Brass See ERRATUM Page 57
	●	80x80x3	1 BP	FK3008D-K2000130	157,91	165,81	189,49	To specify : - BP in 12V or 230V - BP in relief or flush
			2 BP	FK3008D-K2000140	188,24	197,65	225,89	
			4 BP	FK3008D-K2000160	242,91	255,06	291,49	
	●	80x115x3	1 BP	FK3001D-K2000130	165,32	173,59	198,38	
			2 BP	FK3001D-K2000140	195,65	205,43	234,78	
			3 BP	FK3001D-K2000150	224,00	235,20	268,80	
			4 BP	FK3001D-K2000160	250,33	262,85	300,40	
	●	80x142x3	3 BP	FK3003D-K2000150	249,73	262,22	299,68	
			4 BP	FK3003D-K2000160	276,06	289,86	331,27	
			5 BP	FK3003D-K2000170	313,65	329,33	376,38	
	●	80x142x3	6 BP	FK3003D-K2000180	351,23	368,79	421,48	
			1 BP + 1 PC	FK3003D-K2500130	214,64	225,37	257,57	
			2 BP + 1 PC	FK3003D-K2500140	244,97	257,22	293,96	

Button shapes available



Square

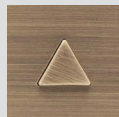

Triangle

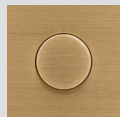

Round



Rectangle



Oval

Back-lighting option:

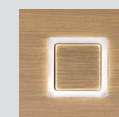

See page 62

CANNELÉE COLLECTION

Designed by Jean-Michel WILMOTTE

SPECIFICATIONS

General

- Switches, reading lamps and sockets (variation only with push buttons or automatic switches)
- Protection index: IP20
- Products must be installed indoors and earthed
- Cleaning only with a soft and dry duster, no product

Covering plate

- Solid brass 5,5mm thick
- With straight edges and non-visible screws
- Different designs are possible on this mount (see page 57)

Control mechanisms

- Elongated base - Ellipse, Seattle or JMA lever or oblong push button
- Chrome-plated on cold and special finishes, golden on warm finishes
- Automatic connection by default, screw connection on request

SIZES & BACK BOXES

Sizes (in mm)	Recommended back boxes
80x80 - 151x80	Type LEGRAND 80051 / LEGRAND 80052

How to fix?

The mounting plate with mechanisms screws directly onto the back box.
The covering plate is magnetized onto the mounting plate.

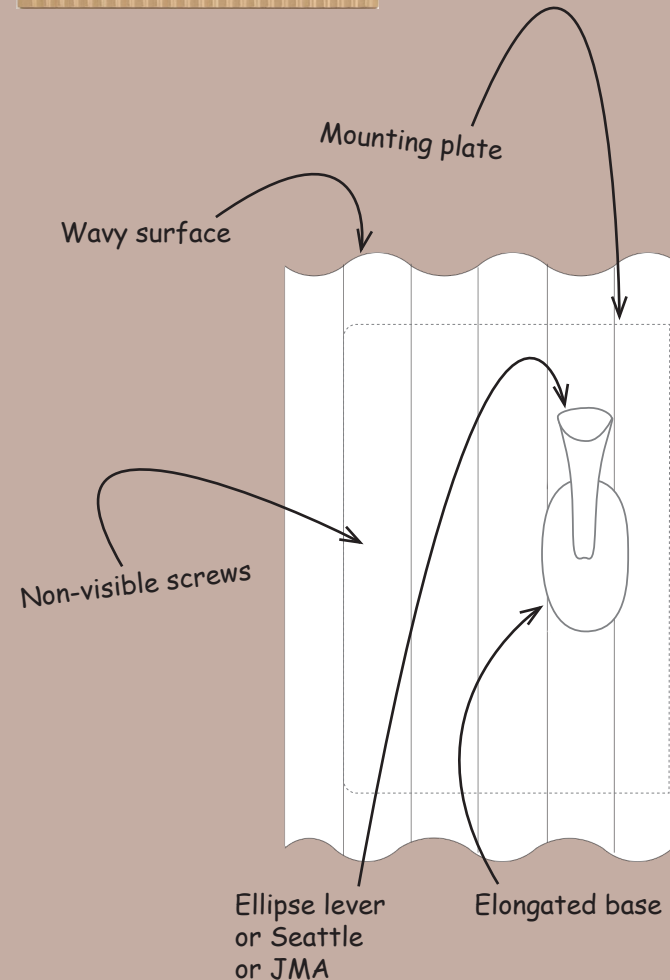

BVCert. 6012053

CANNELÉE



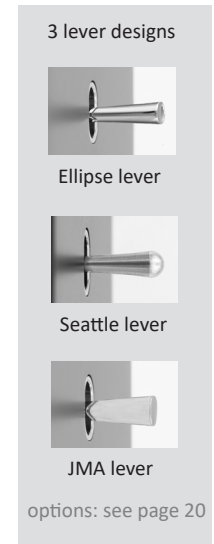
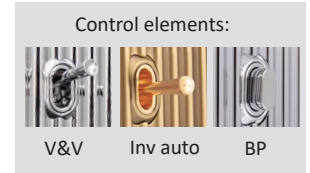











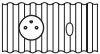

Diagrams	Back box colour	Size (mm)	Fittings	Reference	**Cold finishes	**Warm finishes	**Special finishes	*Attention Polished Brass See ERRATUM Page 57
		80x80x5,5	1 control element	FW5017K-A1100010	172,27	180,88	206,72	**Available finishes = page 57
		80x80x5,5	2 control elements	FW5017K-A1100021	260,08	273,08	312,10	
		80x80x5,5	1 PC 2x10/16A+T	FW5017K-B0000010	118,49	124,41	142,19	
		80x80x5,5	1 RJ45	FW5017K-B0000730	137,33	144,20	164,80	
		80x80x5,5	1 USB socket	FW5017K-B0001211	191,10	200,66	229,32	
		80x80x5,5	1 cable outlet	FW5017K-B0001290	118,22	124,13	141,86	
		80x80x5,5	1 TV outlet	FW5017K-B0001700	118,66	124,59	142,39	
		80x80x5,5	Tactile reading lamp - bend 0°	FW5017K-M3000020	468,47	491,89	562,16	
		80x80x5,5	Tactile reading lamp - bend 135°	FW5017K-M3000010				
		80x80x5,5	1 Thermostat Schneider S520509	FW5017K-K1000127	491,01	515,56	589,21	
		151x80x5,5	3 control elements	FW5022K-A1100032	401,72	421,81	482,06	
		151x80x5,5	4 control elements	FW5022K-A1100042	489,53	514,01	587,44	
		151x80x5,5	5 control elements	FW5022K-A1100052	577,34	606,21	692,81	

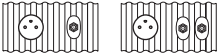

Prices for Ellipse and Seattle toggles only

JMA lever:
26 € additional charge

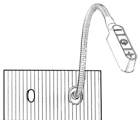
CANNELÉE

Diagrams	Back box colour	Size (mm)	Fittings	Reference	**Cold finishes	**Warm finishes	**Special finishes	*Attention Polished Brass See ERRATUM Page 57
		151x80x5,5	2 PC 2x10/16A+T	FW5022K-B0000020	206,36	216,68	247,63	**Available finishes =  page 57
		151x80x5,5	2 RJ45 3 RJ45	FW5022K-B0000740 FW5022K-B0000750	244,05 296,93	256,25 311,78	292,86 356,32	
		151x80x5,5	1 PC + 1 control element	FW5022K-C0010010	260,14	273,15	312,17	
		151x80x5,5	1 PC + 2 control elements	FW5022K-C0010020	347,95	365,35	417,54	
		151x80x5,5	1 PC + 1 RJ45 1 PC + 2 RJ45	FW5022K-B0010640 FW5022K-B0010710	225,21 278,09	236,47 291,99	270,25 333,71	
		151x80x5,5	1 PC + 1 USB socket	FW5022K-B0028840	278,97	292,92	334,76	
		151x80x5,5	1 PC + 1 TV outlet 1 PC + 2 TV outlets	FW5022K-B0058240 FW5022K-B0058310	206,53 240,74	216,86 252,78	247,84 288,89	
		151x80x5,5	1 control element + 1 tactile reading lamp- bend 0° 1 control element + 1 tactile reading lamp- bend 135°	FW5022K-M3000140 FW5022K-M3000130	610,12	640,63	732,14	

Silkscreen printing option, contact us

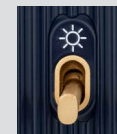

See page 60

SOLARIS COLLECTION

Designed by Marc NEWSON

SPECIFICATIONS

General

- Designed for low voltage (smart homes), can be adapted for line voltage
- Switches and sockets (variation only with push buttons or automatic switches)
- Protection index: IP20
- Products must be installed indoors and earthed
- Cleaning only with a soft and dry duster, no product

Covering plate

- Solid brass 3mm thick
- With straight edges, rounded corners and non-visible screws
- Different finishes are possible (see page 57)

Control mechanisms

- Round base - Flattened toggle or flush concave push button
- Toggle in the same colour as the plate, shiny black base ring, black push button
- Automatic connection by default for automatic reversers (screw connection on request)
- Screw connection for push buttons

SIZES & BACK BOXES

Sizes (in mm)	Back boxes
84x84 - 84x120 - 84x144 - 210x84	Mixed MELJAC, for dry partition and masonry







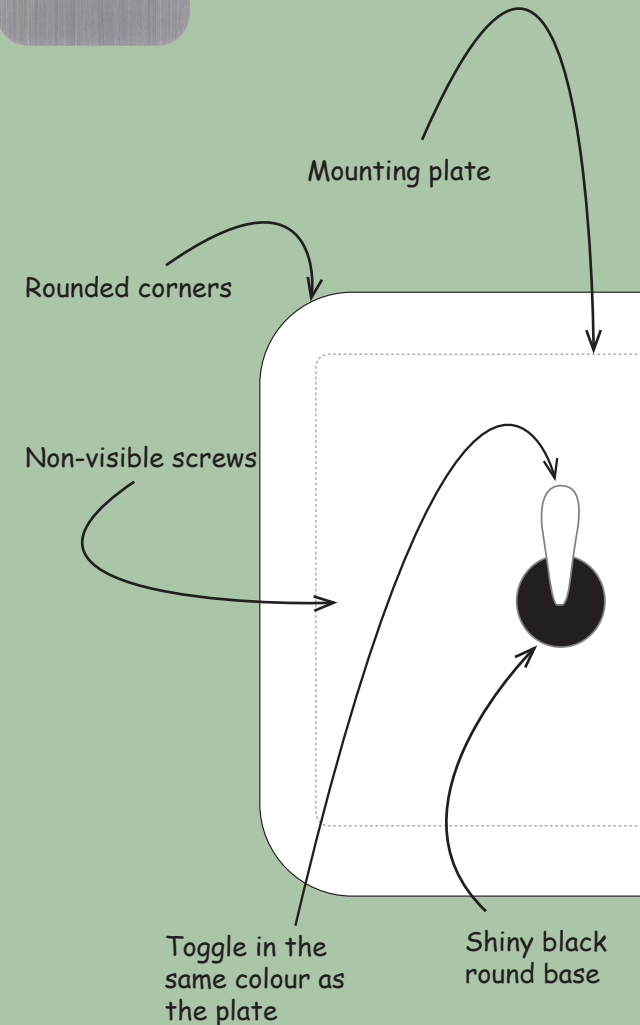



How to fix?

The mounting plate with mechanisms screws directly onto the back box.

The covering plate is clipped onto the mounting plate.





















BVCert. 6012053

Diagrams	Back box colour	Size (mm)	Fittings	Reference	**Cold finishes	**Warm finishes	**Special finishes	*Attention Polished Brass See ERRATUM Page 57
		84x84x3	1 BP	FJ3208M-K2500070	180,47	189,49	216,56	**Available finishes =  page 57
			2 BP	FJ3208M-K2500080	212,32	222,94	254,78	
		84x84x3	1 lever	FJ3208M-A1100010	200,66	210,69	240,79	
			2 levers	FJ3208M-A1100020	289,45	303,92	347,34	
		84x84x3	1 lever + 1 BP	FJ3208M-K2500130	269,26	282,72	323,11	
		84x84x3	1 Thermostat Schneider S520509	FJ3208M-K1000127	485,97	510,27	583,16	
		84x120x3	1 BP	FJ3201M-K2500070	193,01	202,66	231,61	
			2 BP	FJ3201M-K2500080	224,86	236,10	269,83	
			4 BP	FJ3201M-K2500100	266,48	279,80	319,78	
		84x120x3	1 lever	FJ3201M-A1100010	213,20	223,86	255,84	
			2 levers	FJ3201M-A1100020	301,99	317,09	362,39	
			4 levers	FJ3201M-A1100040	479,57	503,55	575,48	
		84x120x3	1 lever + 1 BP	FJ3201M-K2500130	281,80	295,89	338,16	
			3 BP + 1 lever	FJ3201M-K2500170	330,39	346,91	396,47	
		84x120x3	2 BP + 2 levers	FJ3201M-K2500140	402,44	422,56	482,93	
			1 BP + 3 levers	FJ3201M-K2500160	459,38	482,35	551,26	
		120x84x3	1 BP	FJ3200M-K2500070	191,12	200,68	229,34	
			2 BP	FJ3200M-K2500080	222,96	234,11	267,55	
			4 BP	FJ3200M-K2500100	264,59	277,82	317,51	
		120x84x3	1 lever	FJ3200M-A1100010	211,31	221,88	253,57	
			2 levers	FJ3200M-A1100020	300,10	315,11	360,12	
		120x84x3	1 BP + 1 lever	FJ3200M-K2500130	279,90	293,90	335,88	

Prices 03/23 in euros
without VAT

SOLARIS

Diagrams	Back box colour	Size (mm)	Fittings	Reference	**Cold finishes	**Warm finishes	**Special finishes	*Attention Polished Brass See ERRATUM Page 57
			2 BP	FJ3203M-K2500020	248,30	260,72	297,96	
		84x144x3	3 BP	FJ3203M-K2500030	265,04	278,29	318,05	**Available finishes =  page 57
			4 BP	FJ3203M-K2500040	289,92	304,42	347,90	
			6 BP	FJ3203M-K2500120	360,95	379,00	433,14	
								
			2 levers	FJ3203M-A1100020	325,43	341,70	390,52	
		84x144x3	3 levers	FJ3203M-A1100030	414,22	434,93	497,06	
			4 levers	FJ3203M-A1100040	503,01	528,16	603,61	
			6 levers	FJ3203M-A1100060	680,59	714,62	816,71	
		84x144x3	3 levers + 3 BP	FJ3203M-K2500150	531,40	557,97	637,68	
			2 BP	FJ3202M-K2500020	248,30	260,72	297,96	
		144x84x3	3 BP	FJ3202M-K2500030	265,04	278,29	318,05	
			6 BP	FJ3202M-K2500120	360,95	379,00	433,14	
								
			2 levers	FJ3202M-A1100020	325,43	341,70	390,52	
		144x84x3	3 levers	FJ3202M-A1100030	414,22	434,93	497,06	
								

Prices 03/23 in euros
without VAT

SOLARIS

Diagrams	Back box colour	Size (mm)	Fittings	Reference	**Cold finishes	**Warm finishes	**Special finishes	*Attention Polished Brass See ERRATUM Page 57
		84x84x3	1 PC	FJ3208M-B0000010	135,45	142,22	162,54	**Available finishes = page 57
		84x84x3	1 RJ45 2 RJ45	FJ3208M-B0000730 FJ3208M-B0000740	171,60 231,33	180,18 242,90	205,92 277,60	
		84x84x3	1 A or C USB socket 1 AA, CC or AC double USB socket	FJ3208M-B0001211 FJ3208M-B0001221	208,46 215,03	218,88 225,78	250,15 258,04	
		144x84x3	1 PC + 1 control element	FJ3202M-C0010010	260,22	273,23	312,26	
		144x84x3	2 PC	FJ3202M-B0000020	195,00	204,75	234,00	
		144x84x3	1 PC + 1 RJ45	FJ3202M-B0010640	208,29	218,70	249,95	
		144x84x3	1 PC + 1 A or C USB socket 1 PC + 1 AA, CC or AC double USB socket	FJ3202M-B0028841 FJ3202M-B0028911	268,01 274,58	281,41 288,31	321,61 329,50	
		210x84x3	3 PC	FJ3204M-B0000030	283,50	297,68	340,20	
		210x84x3	2 PC + 1 AA, CC or AC double USB socket	FJ3204M-B0028921	363,08	381,23	435,70	
		210x84x3	1 PC + 1 AA, CC or AC double USB socket + 1 RJ45	FJ3204M-B1214291	376,36	395,18	451,63	

Prices 03/23 in euros
without VAT

TOURNAIRE COLLECTION

SPECIFICATIONS

General

- Switches
- Products must be installed indoors and earthed
- Cleaning only with a soft and dry duster, no product

Covering plate

- 6mm-thick cast bronze (brass)
- With straight edges and non-visible screws
- 5 models replicating the six iconic motifs of the jewellery designer TOURNAIRE
- Three of the jewellery designer's 5 iconic motifs can be inlaid with precious stones: Alchimie, Bas-relief and Engrenages.
- Exemple of finishes: Argent Patiné (G5), Nickel Vieilli, Nickel Noir Brillant, Dorure (1N), Bronze Moyen dépoli, Dorure (3N) Vieillie...

Control mechanisms

- Elongated base - Straight lever or Seattle lever with lighting option or push button
- Automatic connection by default, screw connection on request

SIZES & BACK BOXES





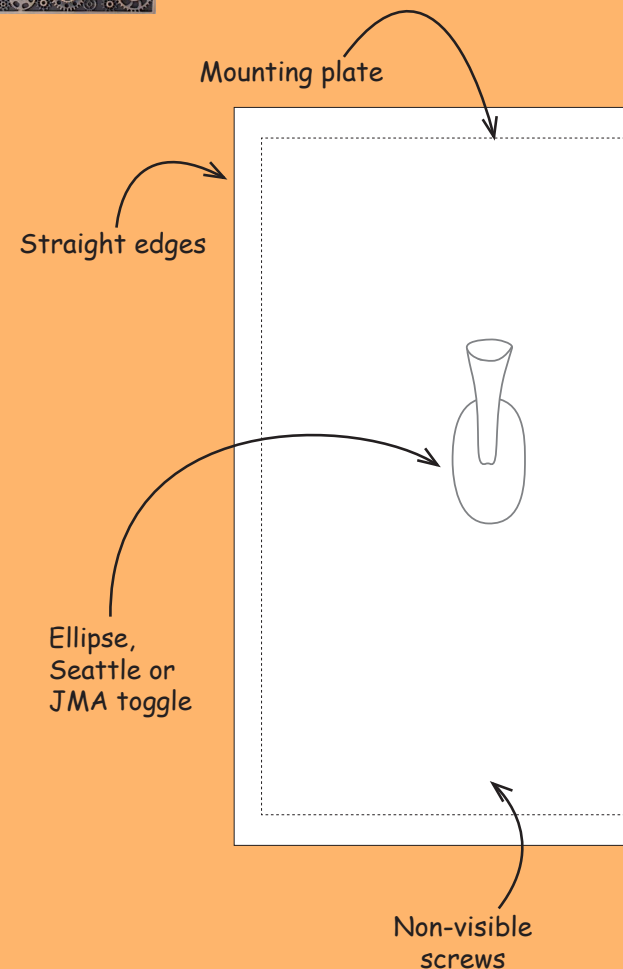

Sizes (in mm)	Recommended back boxes
85x115	Mixed MELJAC, for dry partition and masonry

How to fix?

The mounting plate with mechanisms screws directly onto the back box.
The covering plate snaps onto the mounting plate.



TOURNAIRE COLLECTION

Diagrams	Back box colour	Size (mm)	Fittings	Reference	Special finishes
		85x115x6	1 control element	FA6003D-A1100010	820,19
		85x115x6	2 control elements	FA6003D-A1100020	933,74
		85x115x6	4 control elements	FA6003D-A1100040	1 160,88

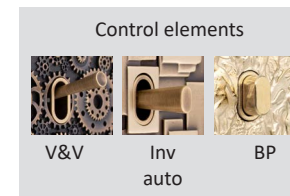

Prices 03/23 in euros
without VAT

Pattern (to be specified when ordering)



Alchimie*



Construction



Engrenages*

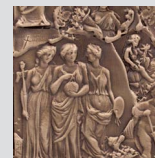

Bas-relief*



Catacombes

*Models that can be set with precious stones.

SOL COLLECTION

SPECIFICATIONS

General

- Sockets with water-resistant cover
- Protection index: IP44
- Products must be installed indoors and earthed (*except for low current*)
- Cleaning only with a soft and dry duster, no product

Covering plate

- Solid brass 10mm thick (*14mm for international*)
- With straight edges and non-visible screws
- Water-resistant cover(s)
- Finishes: Nickel, Chrome, Bronze médaille, Cuivre, Doré, Canon de fusil... (p.57)

SIZES & BACK BOXES







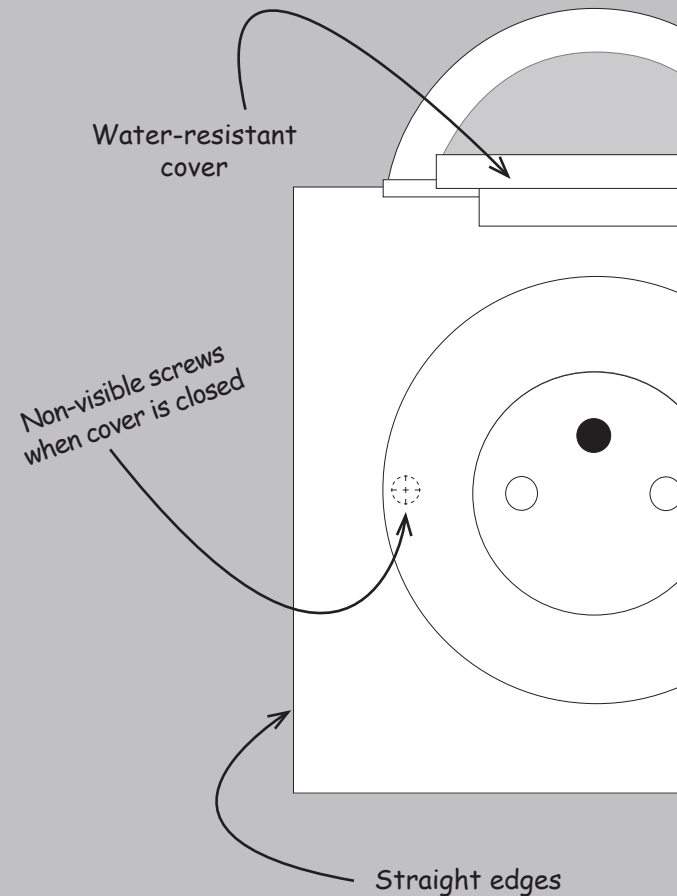

Sizes (in mm)	Back boxes
Ø100 - 100x100 - 180x100 - 180x200	Water-resistant MELJAC with installation template, for masonry only

How to fix?

The back box + installation template set must be sealed flush with the floor.
Then the installation template must be replaced by the covering plate with mechanisms and screws.

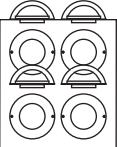

BVCert. 6012053

Diagrams	Back box colour	Size (mm)	Fittings	Reference	Cold finishes	Warm finishes	Special finishes	*Attention Polished Brass See ERRATUM Page 57
		100x100x10	1 PC 2x10/16A+T	FS1000D-B0000010	578,86	607,80	694,63	
			1 RJ45	FS1000D-B0000730	657,73	690,62	789,28	
			1 TV outlet	FS1000D-B0001700	696,40	731,22	835,68	
			2 TV outlets	FS1000D-B0001710	696,40	731,22	835,68	
		Ø100x10	1 PC 2x10/16A+T	FS1003D-B0000010	573,58	602,26	688,30	
			1 RJ45	FS1003D-B0000730	652,46	685,08	782,95	
			1 TV outlet	FS1003D-B0001700	683,57	717,75	820,28	
			2 TV outlets	FS1003D-B0001710	691,13	725,69	829,36	
		180x100x10	2 PC 2x10/16A+T	FS1001D-B0000020	958,18	1 006,09	1 149,82	
			2 RJ45	FS1001D-B0000740	1 115,94	1 171,74	1 339,13	
			2 TV outlets	FS1001D-B0001710	1 058,65	1 111,58	1 270,38	
			1 PC + 1 RJ45	FS1001D-B0010640	1 037,06	1 088,91	1 244,47	
			1 PC + 1 TV outlet	FS1001D-B0058240	1 068,17	1 121,58	1 281,80	
			1 RJ45 + 1 TV outlet	FS1001D-B0060760	1 147,05	1 204,40	1 376,46	
		180x200x10	4 PC 2x10/16A+T	FS1002D-B0000040	1 862,86	1 956,00	2 235,43	
			2 PC + 2 RJ45	FS1002D-B0010720	2 020,62	2 121,65	2 424,74	
			3 PC + 1 RJ45	FS1002D-B0010660	1 941,74	2 038,83	2 330,09	
			2 PC + 2 TV outlets	FS1002D-B0052720	2 082,85	2 186,99	2 499,42	
			3 PC + 1 TV outlet	FS1002D-B0052660	1 972,85	2 071,49	2 367,42	

SOL - EXPORT STANDARD SOCKETS

Diagrams	Back box colour	Size (mm)	Fittings	Reference	Cold finishes	Warm finishes	Special finishes	*Attention Polished Brass See ERRATUM Page 57
	●	100x100x14	1 PC Schuko	FS1400D-B0000250	637,74	669,63	765,29	
			1 RJ45	FS1400D-B0000730	713,30	748,97	855,96	
			1 TV outlet	FS1400D-B0001700	744,42	781,64	893,30	
			2 TV outlets	FS1400D-B0001710	871,48	915,05	1 045,78	
	●	Ø100x14	1 PC Schuko	FS1403D-B0000250	595,52	625,30	714,62	
			1 RJ45	FS1403D-B0000730	671,08	704,63	805,30	
			1 TV outlet	FS1403D-B0001700	702,19	737,30	842,63	
			2 TV outlets	FS1403D-B0001710	709,75	745,24	851,70	
	●	180x100x14	2 PC Schuko	FS1401D-B0000260	1 043,68	1 095,86	1 252,42	
			2 RJ45	FS1401D-B0000740	1 194,81	1 254,55	1 433,77	
			2 TV outlets	FS1401D-B0001710	1 257,04	1 319,89	1 508,45	
			1 PC Schuko + 1 RJ45	FS1401D-B0011480	1 119,25	1 175,21	1 343,10	
			1 PC Schuko + 1 TV outlet	FS1401D-B0059080	1 150,36	1 207,88	1 380,43	
			1 RJ45 + 1 TV outlet	FS1401D-B0060760	1 225,92	1 287,22	1 471,10	
	●	180x200x14	4 PC Schuko	FS1402D-B0000280	2 007,66	2 108,04	2 409,19	
			2 PC Schuko + 2 RJ45	FS1402D-B0011560	2 158,78	2 266,72	2 590,54	
			3 PC Schuko + 1 RJ45	FS1402D-B0011500	2 083,22	2 187,38	2 499,86	
			2 PC Schuko + 2 TV outlets	FS1402D-B0059160	2 241,41	2 353,48	2 689,69	
			3 PC Schuko + 1 TV outlet	FS1402D-B0059100	2 114,34	2 220,06	2 537,21	

To integrate any other mechanism, contact us.

Prices 03/23 in euros
without VAT

VOLUMES COLLECTION

SPECIFICATIONS

General

- Switches, bells, power sockets
- Protection index: IP20
- Products must be installed indoors and earthed
- Cleaning only with a soft and dry duster, no product

Volume

- Solid brass
- Non-visible screws
- Finishes: Nickel, Chrome, Bronze médaille, Cuivre, Doré, Canon de fusil... (p.57)

Control mechanisms

- Round base - Droplet lever or push button
- Chrome-plated on cold and special finishes, golden on warm finishes
Exception: for DOME, 1920, 1951 and rectangular bell block, BP is in the same finish as the object
- Screw connection

SIZES & BACK BOXES

Sizes (in mm)	Recommended back boxes
Macaroons - 1920 - 1930 - 1951 - Dome Square and rectangular bell blocks	LEGRAND 89246, for masonry only
Skate - Palet	LEGRAND 80051, for dry partition only

How to fix?



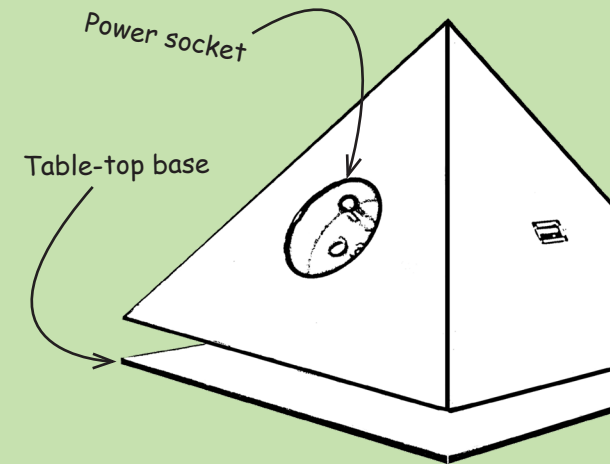
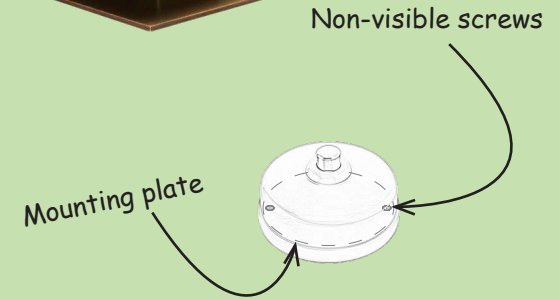









The mounting plate screws directly onto the back box. Then the volume fitted mechanisms with snaps or screws onto the mounting plate. Except for 1951, 1920, rectangular bell block and macaroon, mechanisms are on the mounting plate.



ORIGINE
FRANCE®
GARANTIE

BVCert. 6012053

VOLUMES

Bells	Back box colour	Size (mm)	Fittings	Reference	Cold finishes	Warm finishes	Special finishes	*Attention Polished Brass See ERRATUM Page 57
SQUARE BELL BLOCK 		L.48xI.48xH.17	1 BP 12V	FV9000Z-A1100070	244,93	257,18	293,92	
1951 		L.55xI.55xH.17	1 BP 12V	FV9001Z-A1100070	486,43	510,75	583,73	
DOME 		Ø55xH.36	1 BP 12V	FV9002Z-A1100070	312,51	328,14	375,02	
1920 		L.94xI.52xH.20	1 BP 12V	FV9018Z-A1100070	1 134,01	1 190,71	1 360,82	
RECTANGULAR BELL BLOCK 		L.70xI.46xH.17	1 BP 12V	FV9004Z-A1100070	312,51	328,14	375,02	
MACAROON 		Ø50xH.23	1 BP 12V	FV9005Z-A1100070	172,19	180,81	206,63	







L : length

W : width

H : height

Prices 03/23 in euros
without VAT

VOLUMES

Volumes to fix	Back box colour	Size (mm)	Fittings	Reference	Cold finishes	Warm finishes	Special finishes	*Attention Polished Brass See ERRATUM Page 57
1930 		Ø58xH.32	1 V&V 230V	FV9009Z-A1100010	230,12	241,63	276,14	
			1 BP 230V	FV9009Z-A1100070	225,30	236,55	270,34	
SKATE 		L.80xl.38xH.110	1 V&V 230V	FV9010Z-A1100010	719,11	755,07	862,93	
			1 BP 230V	FV9010Z-A1100070	714,27	749,99	857,12	
PALET 		Ø80xH.19	1 V&V 230V	FV9003Z-A1100010	277,00	290,85	332,40	
			1 BP 230V	FV9003Z-A1100070	273,38	287,04	328,04	

Volumes to put on

PYRAMID 		B.105xH.60	1 BP 12V	FV9006Z-A1100070	983,54	1 032,71	1 180,25	
		L.70xl.42xH.36	1 BP 230V	FV9007Z-A1100070	312,51	328,14	375,02	
PAPER-WEIGHT 		L.103xl.42xH.36	2 BP 230V	FV9008Z-A1100080	379,88	398,87	455,85	
		L.106xl.42xH.36	3 BP 230V	FV9011Z-A1100090	454,56	477,28	545,48	

L : length



W : width

H : height

B : base

Prices 03/23 in euros
without VAT

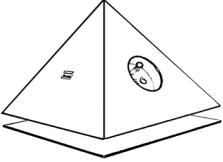
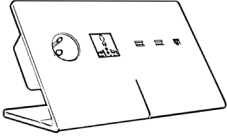
VOLUMES

Models to fix	Size (mm)	Fittings	Reference	Cold finishes	Warm finishes	Special finishes	*Attention Polished Brass See ERRATUM Page 57
	B: L180xI.180 H.146	4 sided power strip 2 PC + 1 RJ45 + 1 Double USB	FV9042Z-B1214300	1 072,10	1 125,69	1 286,51	
Z 	L268xI.114 H.139	Power strip 1 PC 2x10/16A+T + 1 universal outlet + 2 USB + 1 RJ45 Cable 2 m	FV9044Z-B1302010	2 146,41	2 253,72	2 575,69	
Pupitre 	L200xI.106 H.90	1 PC + 1 universal outlet + 1 double USB	FV9039Z-B1001500	943,79	990,98	1 132,55	

Other combinations on request. (PC, RJ45, USB, V&V, BP...), contact us

L : length

W : width

H : height

B : base

Prices 03/23 in euros
without VAT

VOLUMES

Models to put fix		Size (mm)	Fittings	Reference	Cold finishes	Warm finishes	Special finishes	*Attention Polished Brass See ERRATUM Page 57
CHARGEUR IPAD		L.140xL.142 H. 119	Ipad charger support Interchangeable connector compatible with Ipad and Ipad mini	FV9026Z-B0002130	939,82	986,81	1 127,78	

Models to put on

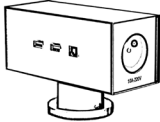
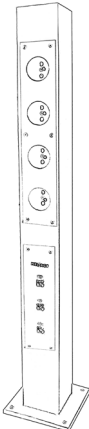
CALYPSO		L.158xL.70 H. 110	Power strip 2 PC 2x10/16A+T + 2 USB + 1 RJ45 Cable 2 m	FV9040Z-B1302010	804,30	844,52	965,16	
TOTEM		B: 120x120 H. 700	Power strip 4 PC 2x10/16A+T + 3 RJ45 Cable 2 m	FV9023Z-B0010800	1 100,26	1 155,28	1 729,25	

L : length

W : width

H : height

B : base

Prices 03/23 in euros
without VAT

PIERROT COLLECTION

SPECIFICATIONS

General

- Switches and sockets
- Protection index: IP20 (*IP21 on request*)
- Products must be installed indoors and earthed
- Cleaning only with a soft and dry duster, no product

Covering plate

- Toughened glass 4mm thick
- With chamfer and visible screws
- Choice of colour in the RAL colour chart

Control mechanisms

- Round base - Droplet lever or push button
- Chrome-plated or golden
- Automatic connection by default, screw connection on request

SIZES & BACK BOXES

Sizes (in mm)

Ø98 - 80x80 - 115x80 - 80x142

Back boxes

Mixed MELJAC, for dry partition and masonry

How to fix?

The covering plate is directly screwed onto the back box.

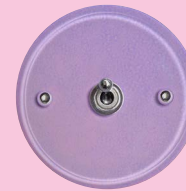











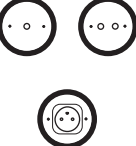

Visible screws

Round base
Droplet lever

Chamfer

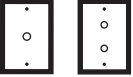

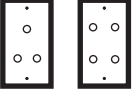
BVCert. 6012053

Diagrams	Back box colour	Size (mm)	Fittings	Reference	Any RAL colour
		80x80x4	1 control element 2 control elements	FP4000A-A1100010 FP4000A-A1100021	203,94 274,13
		80x80x4	1 PC 1 RJ45 1 USB	FP4108A-B0000010 FP4108A-B0000730 FP4108A-B0001211	200,14 222,11 274,53
		Ø98x4	1 control element 2 control elements	FP4001A-A1100010 FP4001A-A1100021	211,74 281,93
		Ø98x4	1 PC	FP4109A-B0000010	207,94
		80x115x4	1 control element 2 control elements	FP4003A-A1100010 FP4003A-A1100020	200,20 270,39
		80x142x4	3 control elements in triangle 4 control elements	FP4005A-A1100031 FP4005A-A1100040	373,19 443,38

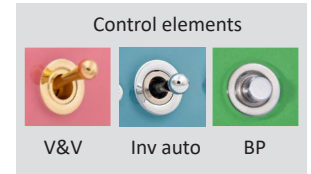

PLEXIGLASS PRODUCTS

SPECIFICATIONS

General

- Switches and sockets
- Protection index: IP20 (IP21 on request)
- Products must be installed indoors and earthed (except for low current)
- Cleaning only with a soft and dry duster

Covering plate

- Solid brass 3mm thick
- With chamfer and visible screws
- Transparent

Control mechanisms

- Round base - Droplet lever or push button
- Chrome-plated or golden
- Automatic connection by default, screw connection on request

SIZES & BACK BOXES

Sizes (in mm)	Recommended back boxes
80x80 - 80x115 - 80x142 - 115x80 - 142x80	Mixed MELJAC, for dry partition and masonry
38x91 - 38x133	Narrow MELJAC, for masonry only







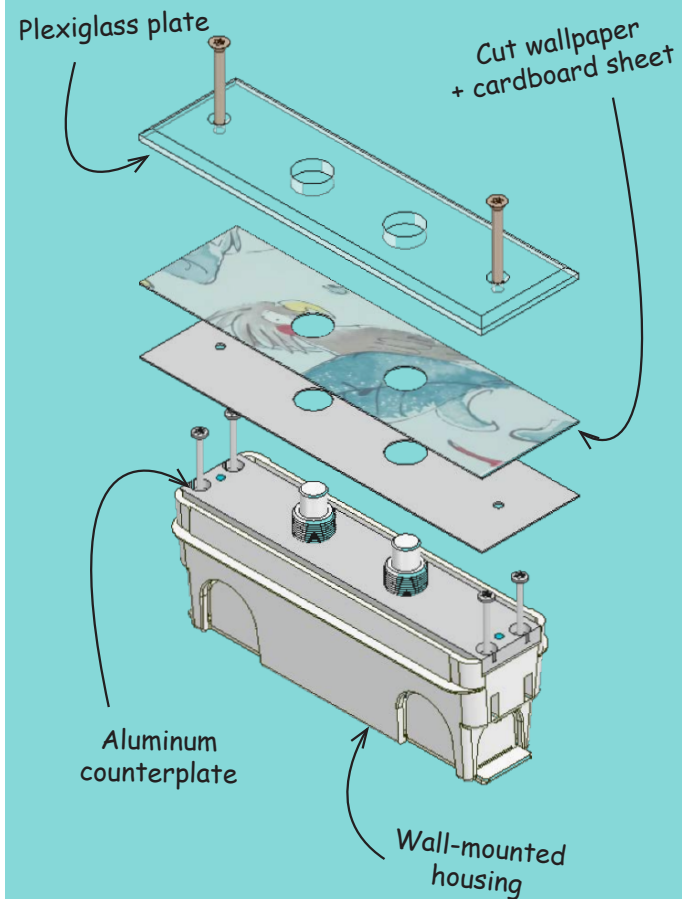



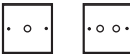



















How to fix?

The aluminum counterplate equipped with the mechanisms screws directly onto the wall-mounted housing. The plexi cover plate is fixed onto this counterplate with 2 screws.

To be fitted beforehand: the cut wallpaper and the card provided.



PLEXIGLASS

Diagrams	Back box colour	Size (mm)	Fittings	Reference	Transparent
		80x80x3	1 control element 2 control elements	FX3008A-A1100010 FX3008A-A1100021	82,01 95,47
		80x80x3	1 PC 2x10/16A+T	FX3008A-B0000010	80,52
		80x80x3	1 RJ45 2 RJ45	FX3008A-B0000730 FX3008A-B0000740	95,38 146,83
		80x80x3	1 Type A USB socket 1 double Type A USB socket	FX3008A-B0001211 FX3008A-B0001221	168,49 176,59
		38x91x3	1 control element	FX3011A-A1100010	81,81
		38x133x3	2 control elements	FX3010A-A1100020	98,71
		80x115x3	1 control element	FX3001A-A1100010	85,46
		80x115x3	2 control elements	FX3001A-A1100020	98,71
		115x80x3	1 PC 2x10/16A+T	FX3000A-B0000010	98,63
		115x80x3	1 RJ45 2 RJ45	FX3000A-B0000730 FX3000A-B0000740	117,93 162,39
		115x80x3	1 Type A USB socket 1 double Type A USB socket	FX3000A-B0001211 FX3000A-B0001221	171,93 180,08
		142x80x3	2 PC 2x10/16A+T	FX3002A-B0000020	148,86
		142x80x3	1 PC + 2 control elements	FX3002A-C0010020	166,27
		142x80x3	1 PC + 2 RJ45	FX3002A-B0010710	208,47
		142x80x3	1 PC + 1 double Type A USB socket	FX3002A-B0028911	214,20

Control elements



V&V

Inv auto

BP

Other types of sockets
available on demand

Other combinations of
mechanisms on request,
Please contact us

Prices 03/23 in euros
without VAT

LIMOGES CLASSIQUE COLLECTION

SPECIFICATIONS

General

- Switches
- Protection index: IP20 (*IP21 on request*)
- Products must be installed indoors and earthed
- Cleaning only with a soft and dry duster, no product

Covering plate

- Limoges porcelain 3mm thick
- With straight edges and non-visible screws
- Porcelain glazed (*white colour by default, contact us for other colours*) or biscuit (*white colour only*)

Control mechanisms

- Round base - Droplet lever or push button
- Chrome-plated or golden
- Automatic connection by default, screw connection on request

SIZES & BACK BOXES

Sizes (in mm)	Type of back box
80x80 - 115x80 - 142x80	Mixed MELJAC, for dry partition and masonry
38x133	Narrow MELJAC, for masonry only





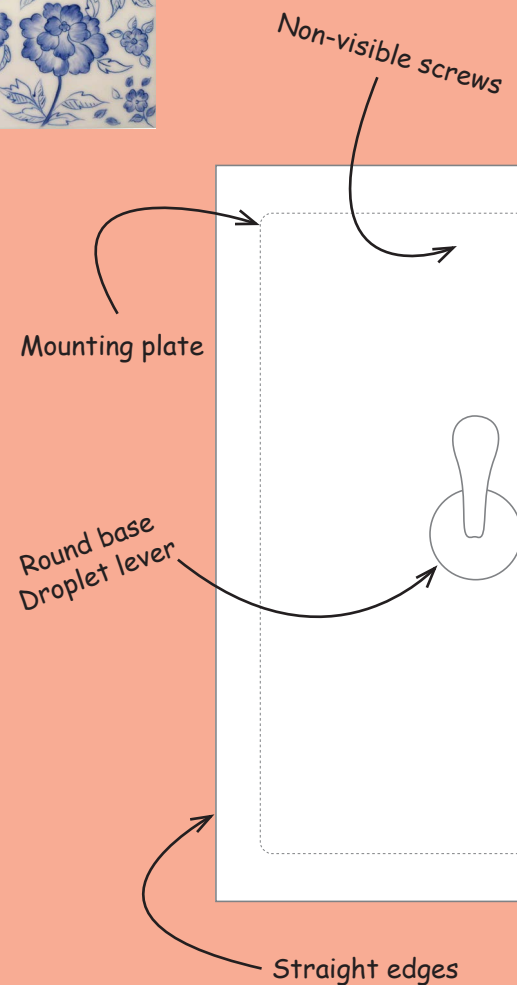



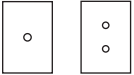

How to fix?

The mounting plate with mechanisms screws directly onto the back box.
The covering plate snaps onto the mounting plate.

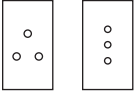

BVCert. 6012053

LIMOGES CLASSIQUE

Diagrams	Back box colour	Size (mm)	Fittings	Reference	White colour
		80x80x3	1 control element	FL3008D-A1100010	170,27
			2 control elements	FL3008D-A1100020	258,83
		80x115x3	1 control element	FL3001D-A1100010	176,63
			2 control elements	FL3001D-A1100020	265,19
		80x142x3	3 V&V , Inv auto or BPE in triangle	FL3003D-A1100031	374,14
			3 BP in line	FL3003D-A1100090	
		80x142x3	4 control elements	FL3003D-A1100040	462,70
		38x133x3	1 control element	FL3010D-A1100010	176,63
			2 control elements	FL3010D-A1100020	265,19

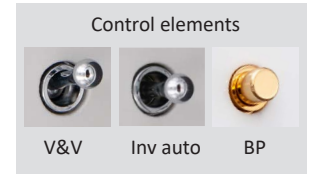

Prices 03/23 in euros
without VAT

LIMOGES ELLIPSE COLLECTION

SPECIFICATIONS

General

- Switches
- Protection index: IP20 (*IP21 on request*)
- Products must be installed indoors and earthed
- Cleaning only with a soft and dry duster, no product

Covering plate

- Limoges porcelain 3mm thick
- With straight edges and non-visible screws
- Porcelain glazed (*white colour by default, contact us for other colours*) or biscuit (*white colour only*)

Control mechanisms

- Elongated base - Straight lever or Seattle lever with lighting option or oblong push button
- Chrome-plated or golden
- Automatic connection by default, screw connection on request

SIZES & BACK BOXES

Sizes (in mm)	Type of back box
80x80 - 115x80 - 142x80	Mixed MELJAC, for dry partition and masonry
38x133	Narrow MELJAC, for masonry only





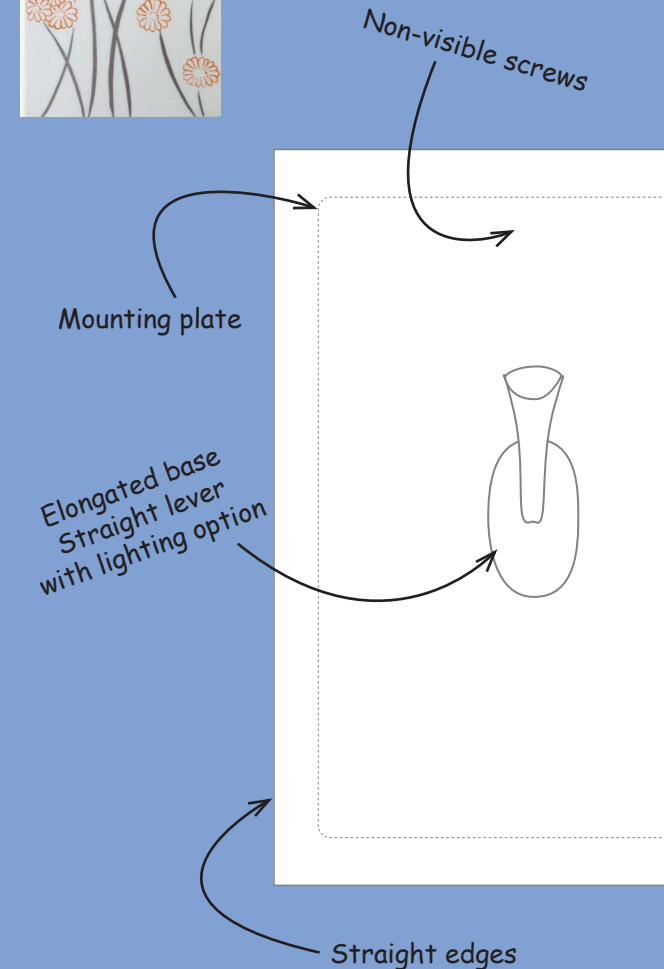



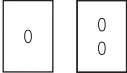

How to fix?

The mounting plate with mechanisms screws directly onto the back box.
The covering plate snaps onto the mounting plate.



BVCert. 6012053

LIMOGES ELLIPSE

Diagrams	Back box colour	Size (mm)	Fittings	Reference	White colour
		80x80x3	1 control element	FM3008D-A1100010	170,27
			2 control elements	FM3008D-A1100020	258,83
		80x115x3	1 control element	FM3001D-A1100010	176,63
			2 control elements	FM3001D-A1100020	265,19
		80x142x3	3 V&V , Inv auto or BPE in triangle	FM3003D-A1100031	374,14
			3 BP in line	FM3003D-A1100090	374,14
		80x142x3	4 control elements	FM3003D-A1100040	462,70
		38x133x3	1 control element	FM3010D-A1100010	176,63
			2 control elements	FM3010D-A1100020	265,19

Control elements

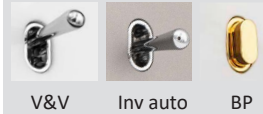

3 lever designs



Ellipse lever



Seattle lever



JMA lever

options: see page 20

Prices for Ellipse and
Seattle toggles only

JMA lever:
26 € additional charge

Prices 03/23 in euros
without VAT

CRESTRON CONNECTED COLLECTION

SPECIFICATIONS

General

- Collection designed for direct connection to the Crestnet bus
- Push buttons
- Protection index: IP20
- Products must be installed indoors and earthed
- Cleaning only with a soft and dry duster, no product

Covering plate

- Solid brass 3mm thick
- With straight edges and non-visible screws
- Finishes: Nickel, Chrome, Bronze médaille, Cuivre, Doré, Canon de fusil...

Control mechanisms

- Push buttons $\varnothing 12$ mm, 2 mm thick
- In the same finish as the covering plate
- Led feedback for each button
- Circuit board with integrated Crestron chip

SIZES & BACK BOXES

Sizes (in mm)	Recommended back boxes
80x115	Mixed MELJAC, for dry partition and masonry





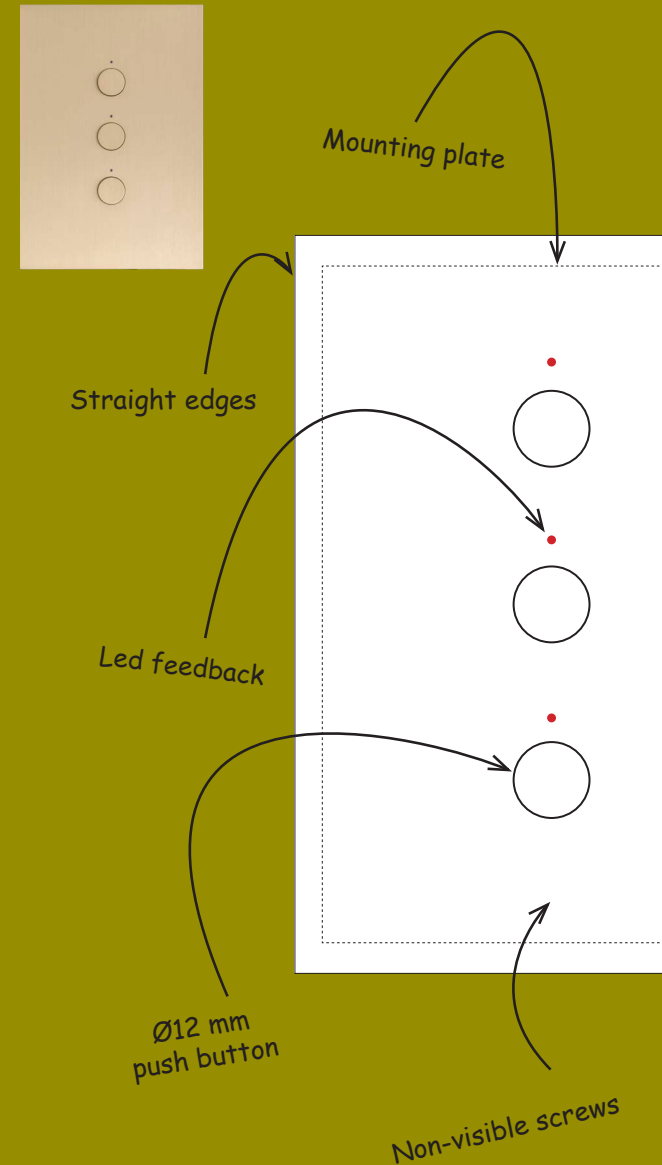



How to fix?

The mounting plate with mechanisms screws directly onto the back box.
The covering plate snaps onto the mounting plate.



BVCert. 6012053

CRESTRON CONNECTED

Diagrams	Back box colour	Size (mm)	Fittings	Reference	Cold finishes	Warm finishes	Special finishes	*Attention Polished Brass See ERRATUM Page 57
		80x115x3	1 BP	FO3001C-K2500410	361,00	379,05	433,20	
		80x115x3	2 BP	FO3001C-K2500420	391,00	410,55	469,20	
		80x115x3	3 BP	FO3001C-K2500430	421,00	442,05	505,20	
		80x115x3	6 BP	FO3001C-K2500460	511,00	536,55	613,20	

Prices 03/23 in euros
without VAT

Control elements examples with options



Fittings	Reference	Price from
2 BP	FO3001C-K2500420	391,00
Engraving 1 word	FZ9999Z-ZGR0001M99	+ 16,00
Engraving 1 additional word	FZ9999Z-ZGR1001M99	+ 6,00

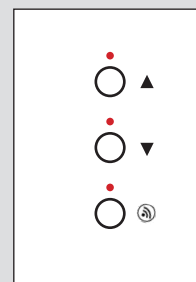

Fittings	Reference	Price from
3 BP	FO3001C-K2500430	421,00
Engraving 1 symbol	FZ9999Z-ZGR0001S99	+ 16,00
Engraving 1 additional symbol	FZ9999Z-ZGR1001S99	+ 6,00
Engraving 1 pictogram	FZ9999Z-ZGR0001P99	+ 22,00

SPOTLIGHT COLLECTION

SPECIFICATIONS

General

- Recessed spotlights for false ceiling
- Protection index: IP54 CLASS II
- Products must be installed indoors in a false ceiling and earthed
- Cleaning only with a soft and dry duster, no product

Covering plate

- Solid brass 3mm thick
- With straight edges, without screws
- Standard sizes: 58x58 mm and Ø58 mm
- Finishes: Nickel, Chrome, Bronze médaille, Cuivre, Doré, Canon de fusil... (p.57)

Technical specifications

- Direct or asymmetric LED lighting
- Power: 230V - 5W
- Beam angle: 24°.
- Light color: warm white (2700K) or cool white (4000K)

How to fix?

The transformer is fixed in the false ceiling.
The cover plate snaps onto the spotlight.



Mini Spot

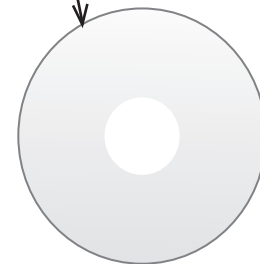

Straight edges covering plate



BVCert. 6012053

SPOTLIGHTS

Diagrams	Installation	Size (mm)	Fittings	Reference	Cold finishes	Warm finishes	Special finishes	*Attention Polished Brass See ERRATUM Page 57
Direct lighting								
DIRECT LIGHTING								
SQUARE		Ceiling cut Ø45mm	58x58x3	Mini Spot 2700K-warm	FB3013C-Z5000010	140,04	147,04	168,05
				Mini Spot 4000K-cold	FB3013C-Z5000020			
ROUND		Ceiling cut Ø45 mm	Ø58x3	Mini Spot 2700K-warm	FB3014C-Z5000010	143,13	150,29	171,76
				Mini Spot 4000K-cold	FB3014C-Z5000020			
Asymmetric lighting								
SQUARE		Ceiling cut Ø45 mm	58x58x3	Mini Spot 2700K-warm	FB3013C-Z5000011	140,04	147,04	168,05
				Mini Spot 4000K-cold	FB3013C-Z5000021			
ROUND		Ceiling cut Ø45 mm	Ø58x3	Mini Spot 2700K-warm	FB3014C-Z5000011	143,13	150,29	171,76
				Mini Spot 4000K-cold	FB3014C-Z5000021			
Both models are available with white or black interior, to specify								





















Prices 03/23 in euros
without VAT

MATERIALS & FINISHES

The collections CLASSIQUE, ELLIPSE, DAMIER, ELLIOT, CANNELÉE, SOLARIS, SOL with water-resistant cover, VOLUMES, SPOTS and LAMPES are made in brass. The finishes are obtained by electrolysis.

The PIERROT collection is in toughened extra white glass. The paint is applied at the rear and highlighted by the transparency and thickness of the glass.













The LIMOGES collections are in Limoges Porcelain.

Material & fittings	Finish & description
TF Brass Cold finishes <i>With chrome-plated V&V, BP, BPE and Inv</i>	Nickel Brossé (FA)  <i>Stainless-steel aspect.</i>
	Nickel Brillant (FB)  <i>Mirror effect, tone slightly hotter than chrome.</i>
	Microbillé Nickel (FC)  <i>Sandy surface, matt varnish.</i>
	Chromé Mat (FD)  <i>Linear brushing. Bluish grey hue.</i>
	Chromé Vif (FE)   <i>Mirror with bluish sheens.</i>
	Canon de Fusil Anthracite (FF)   <i>Brushing. Dark grey tone, tend toward brown.</i>
	Canon de Fusil Sablé (FH)  <i>Granite aspect. Dark grey tone.</i>
TC Brass Warm finishes <i>With golden V&V, BP, BPE and Inv</i>	Bronze Médaille Clair (CA)   <i>Golden bronze slightly brushed. Satiny varnish.</i>
	Bronze Médaille Clair Vernis Mat (CB)  <i>Golden bronze slightly brushed. Matt varnish.</i>
	Bronze Médaille Allemand (CC)  <i>Linear brushing, medium bronze.</i>
	Bronze Médaille Foncé (CD)   <i>Dark brown hue.</i>
	Champagne (CE)   <i>Brushed brass. Matt varnish.</i>
	Doré Patiné (CF)  <i>Gold yellow hue. Slightly brushed and satiny varnish.</i>

Meljac can carry out special finishes on demand (example: different types of gilding, etc.) or customised.

Available finishes on collection Cannelée 

Available finishes on collection Solaris 

Material & fittings	Finish & description
TS Brass Special finishes <i>With chrome or gilding controls</i>	Nickel Noir Brillant (SA)
	Nickel Noir Mat (SB)
	Microbillé Chromé (SF)
	Argent Patiné (SE)  
	Cuivre Patiné (SG) 
	Cuivre Vieilli Bouchonné (SH) 
	Cuivre Satiné (SI)  
	Microbillé Canon de Fusil Anthracite (SM)
	Ebène (SQ)
	Canon de Fusil Belge (SP) 
	Laiton Vieilli Ciré (SR) 
	Étain Moyen (SS) 
	Cuivre Antique (ST) 
Antique Brass NA (SU) 	
Black Stone Chelsea (SV)	
Laiton Poli Verni (SX) <i>Gold aspect mirror effect.</i>  	
Epoxy Brass / Glass RAL colours <i>With chrome-plated or golden V&V, BP, BPE and Inv</i>	RAL colours (RL) Selection in the RAL colour chart (K7 classic) Specify name and number
Limoges Porcelain <i>With chrome-plated V&V, BP, BPE and Inv</i>	White Glazed (LA) <i>Shiny surface</i> Other colours on request. Custom designs possible
	White Biscuit (LB) <i>Matt sandblasted surface</i> Custom designs possible

*ERRATUM

As from November 2023, our Polished Brass finish will be replaced by the Shiny Gilding 1 gloss finish. Visually very similar, it offers a higher level of quality. Due to its composition, prices in this shade are 20% higher than special finishes.

Care instructions

Metal-coated surfaces must be cleaned with a soft and dry duster only, no product.

All the products must be installed indoors.

SAMPLE BOX & TUBES

Prices and delivery time upon request



The tube contains a selection of 10 finishes:

Nickel Brossé, Canon de Fusil Anthracite, Ébène, Nickel Noir Mat, Chromé Vif, Champagne, Bronze Médaille Clair, Bronze Médaille Allemand, Bronze Médaille Foncé, Laiton Poli Verni.



The box contains all the finishes.

*Actual products may differ from photos

TECHNICAL INFORMATION - GENERAL

Direction of covering plate

All MELJAC products fix onto back boxes.

The screws are supplied in the same finish as plates.

By default, the axis of the cover plate screws is:

- vertical for control mechanisms (V&V, BP, BPE...)
- horizontal for sockets
- horizontal for 80x80 and Ø98 sizes

Colour of switches

On brass, the switches are:

- chrome-plated on cold and special finishes
- golden on warm finishes

Mini mechanisms (12V) are chrome-plated only

Switches are chrome-plated or golden for glass, porcelain and plexiglass.

Accessories in the same finish as the plate:

- rotary buttons for variation
- caps of mini push buttons
- square push buttons from DAMIER collection
- bell buttons of Dome, 1951, 1920 and rectangular block
- cable lead-out (cable outputs, markings)

Light label holder

Two shapes are available. Specify when ordering: rectangular or elliptical.

Position of indicators, engravings (simple, complex, light...) and light label holder

By default, MELJAC selects the most harmonious position for fittings on the covering plate.

Care instructions

Products must be installed indoors

Cleaning only with a soft and dry duster, no product

Standards

MELJAC creations are protected in France and abroad by the copyright, the registration of models and several patents.

Probate by the norms:

- NF EN 60669-1 + A1 for switches, push buttons and reversers.
- NF C 61314 for power sockets.

For probates in process, contact us.

Following the established standard NF C 15100, each plate has to be connected to earth.

Each pattern is outfitted with a patented system of connection to earth.





Stamping CE.

Protection index: IP20 except for Sol collection IP44 and water resistant spotlights IP54 CLASS II.

NB : For any special requirement, please clarify and / or provide a diagram when you place an order.

OPTIONS (ENGRAVING, TOGGLE WITH COATING)

These options are sold separately, so do not forget to specify them at the order.

	Type of option	Designation	Reference	Price
	Engraving : - standard font: Helvetica uppercase height 4mm - Russian standard font: Arial Narrow 4 mm - word, figure, symbol, triangle = simple symbol - pictogram = complex symbol - triangles = per pair, on both sides of the switch (standard position: up/down)	Engraving 1 word	FZ9999Z-ZGR0001M99	16,00
		Engraving 1 figure	FZ9999Z-ZGR0001C99	
		Engraving 1 symbol	FZ9999Z-ZGR0001S99	
		Engraving 2 triangles	FZ9999Z-ZGR0002T99	
			Additional simple engraving on the same plate	Engraving 1 pictogram
Engraving 1 additional word	FZ9999Z-ZGR1001M99			6,00
Engraving 1 additional figure	FZ9999Z-ZGR1001C99			
Engraving 1 additional symbol	FZ9999Z-ZGR1001S99			
	Additional complex engraving on the same plate	Engraving 2 additional triangles	FZ9999Z-ZGR1002T99	
	Laser engraving (contact us for existing designs, we can also create new)	Engraving 1 additional pictogram	FZ9999Z-ZGR1001P99	
	Resin engraving (contact us for existing designs, we can also create new)	Laser engraving 1 word	- - -	Please contact us
	Silkscreen printing (words, symbols, pictograms, photographs...)	Silkscreen printing	- - -	Please contact us
	Resin (specify colour)	Resin engraving	FZ9999Z-ZR00001M99	28,00
	Additional resin on the same plate (specify colour)	Resin engraving 1 additional word	FZ9999Z-ZR10001M99	8,00
	Mirror-polished oblong base In bright chrome or gold for Ellipse lever switches	Mirror-polished	FZPLVAZ-Z0000050ZZ	36,00
	JMA lever switch subject to additional charge With oblong base	JMA lever	FZPLVAZ-Z0000040ZZ	26,00
	Additional charge for mechanism processing Processing possible on request for V&V, BP and Inv switches.	Processed mechanisms	FZPLVAZ-Z0000010ZZ	from 16,00

Prices 03/23 in euros
without VAT

Example of options

LED indicator



Oblong light base
Ellipse collection



Luminous numbers



Indicator Q8 model



Oblong light base
Elliot collection



Light engraving



OPTIONS (LED INDICATORS, BACK-LIGHTING)

These options are sold separately, so do not forget to specify them at the order.

	Type of option	Designation	Reference	Price
	LED Indicator - Ø 3 mm - LED colour : Warm white, Blue, Pure Green, Yellow Green, Yellow, Orange, Red White cold	LED D3 30V-1mA (automation) LED D3 12V-1mA LED D3 24V-1mA LED D3 230V-1mA	FZLED0Z-Z00D303099 FZLED1Z-Z00D301299 FZLED1Z-Z00D302499 FZLED2Z-Z00D323099	15,66
	Oblong light base LED light strip Several colours available Interior lighting of toggle base is not available in the Cannelée collection.	LED D3 12V-1mA for Ellipse collection LED D3 24V-1mA for Ellipse collection LED D3 230V-1mA for Ellipse collection	FZLED3Z-Z00D301299 FZLED3Z-Z00D302499 FZLED3Z-Z00D323099	19,79
	Back-lighting of Damier buttons Illuminated button surround Several colours available	1 colour (12V 1mA)	FZLEDZ-Z001RT01299	26,18
		1 colour (24V 1mA)	FZLEDZ-Z001RT02499	
		1 colour (12V 1mA) night brightness	FZLEDZ-Z002RT01299	32,89
		1 colour (24V 1mA) night brightness	FZLEDZ-Z002RT02499	
		2 colours (12V 1mA)	FZLEDZ-Z003RT01299	36,40
		2 colours (24V 1mA)	FZLEDZ-Z003RT02499	
		2 colours (12V 1mA) night brightness	FZLEDZ-Z004RT01299	39,90
2 colours (24V 1mA) night brightness	FZLEDZ-Z004RT02299			
	Light engraving Light label holder	Light ribbon supplied in 24V- Available in green or red	FZ9999Z-ZGLU000199	88,11
		Additionnal light ribbon supplied in 24V- Available in green or red	FZ9999Z-ZGLU100199	41,33

Prices 03/23 in euros
without VAT

Mechanisms provided (since 2010)

Automatic connection
(by default)



Screw connection
(on request)



Former mechanism

Screw connection
only



Connection

Use rigid cable of section 1,5 mm² stripped on 13 mm for automatic connection or 10 mm for screw connection

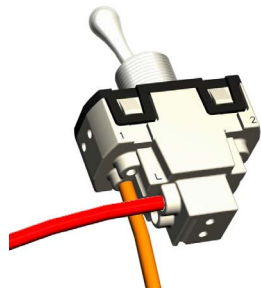

V&V
wired in ON/OFF function

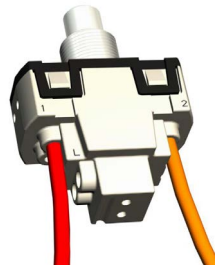

BP
wired in ON/OFF function

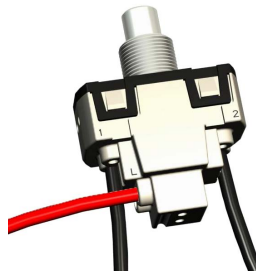

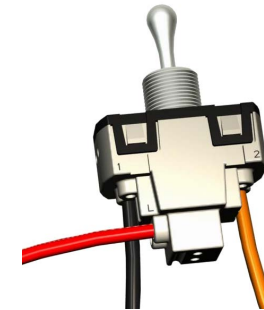

BPE
wired in two-way function



Inv Auto

MECHANISMS CONTROLS, READING LAMPS

Type	Abbreviations	Symbole	Designation	Technical specifications
Switches <i>buttons and levers are chrome-plated on cold and special finishes, golden on warm finishes</i>	V&V		Toggle switch	Lever wired in one-way switch or two-way switch between 2 ignition points - automatic connection (default): 6A/250V - screw connection (on request): 6A/250V
	BP		Push button	Button wired in dimmer, one-way switch or two-way switch between 2 or more ignition points - automatic connection (default): 6A/250V - screw connection (on request): 2A/250V It MUST work with a teleruptor or a dimmer in the electrical equipment box
	BPE		Latching push button	Latching button wired in one-way switch or two-way switch between 2 ignition points - automatic connection ONLY: 6A/250V
	Inv Auto		Automatic Reverser	Three-position lever for roller shutters (2 positions + automatic return to 0) Possibility to control lighting - automatic connection (default): 6A/250V - screw connection (on request): 6A/250V Also available in manual for roller shutters only (manual return to 0)
	Mini BP		Mini push button	Button wired in dimmer, one-way switch or two-way switch between 2 or more ignition points - connection to weld: 12V It MUST work with a teleruptor or a dimmer in the electrical equipment box Silent mini BP, available on request
	square BP		Square push button	Button wired in dimmer, one-way switch or two-way switch between 2 or more ignition points - screw connection ONLY: 12V or 230V It MUST work with a teleruptor or a dimmer in the electrical equipment box
	---		Motion detector	Automatic switch - 240V - Model LEGRAND 67026 Lighting control, manual by On/Off push buttons or automatic by infrared detection
Variation	Var E Rotary dimmer		SCHNEIDER NU351618 model	Bluetooth Model, Universal. For LED, incandescent, halogen and transformer lamps.
			SCHNEIDER S520519 model	Universal. For LED, incandescent, halogen and transformer lamps.
	Room thermostat		LEGRAND 76720 model	Room thermostat, optional hot/cold selector available Suitable for controlling heated ceilings and underfloor heating from 5°C to 30°C with an accuracy of +/- 0,5°C
	Room/floor thermostat		SCHNEIDER S520507 model	Electronic room thermostat with floor temperature limitation sensor, 2 integrated LEDs Suitable for controlling room temperature with floor heating systems, heating from 5°C to 45°C with an accuracy of +/- 0,5°C - Ambient option available
Room and floor thermostat		SCHNEIDER S520509 model	Electronic room thermostat with floor temperature limitation sensor, with touch screen and pilot wire Suitable for controlling room temperature with floor heating systems, heating from 5°C to 45°C with an accuracy of +/- 0,5°C	
Reading lamp	---	---	Reading lamp	Wall lamp : - Lighting (provided): 1,4 W LED supplied by a 350 mA electronic converter - Beam: 60° for Roseau model and 45°, 60° (default) or 110° for Tulipe model - Lampshade : straight or beveled cone for Tulipe model - Flexible arm : 25 cm with or without a 135° bend connection
			Tactile reading lamp	- Lighting : LED 3500 K, from 47,1 to 66,9 lumens - Variable luminous intensity - Flexible arm : 25 cm with or without bend a 135° connection

PC or PC Schuko : automatic connection

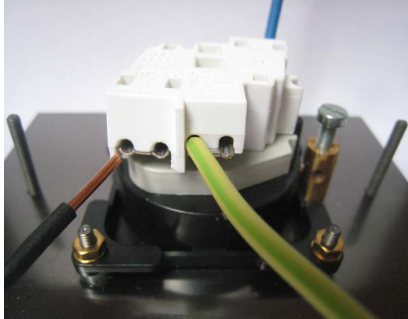

Use rigid cable of section 2,5 mm²
stripped on 13 mm



How to extract cable

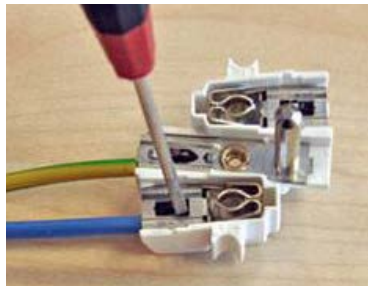

Renovation

Since 2016, MELJAC products are fitted with
a new socket mechanism (France or Schuko)
that takes less space.

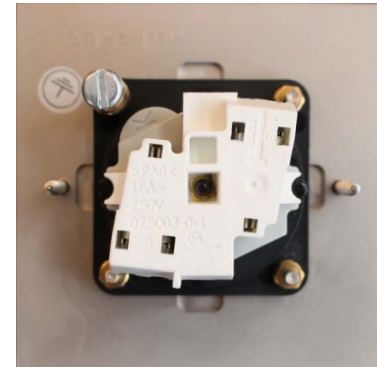

CLASSIQUE collection plates 80x80mm can be
mounted on most of the existing back boxes
in renovation.

MECHANISMS OUTLETS (high voltage, low voltage)

Type	Abbreviations	Symbole	Designation	Technical specifications
Power socket	PC		Power socket	French model 2x10/16A+T with child security Sockets are black by default, off-white on request
	Universal PC		Wonpro power socket	Wonpro R45 model. Universal socket 2x16A+T with child security Sockets are black by default, off-white on request Prior agreement from a control authority required
	PC Schuko		Schuko power socket	German / european model 2x10/16A+T with child security Sockets are black by default, off-white on request
	PC Bipasso		Bipasso power socket	Italian model 2x10/16A+T with child security
	PC Unel		Unel power socket (Schuko + Bipasso)	European model 2x10/16A+T with child security Sockets are black by default, off-white on request
Phone/Data Connection	RJ45 without PE		Data socket without white label holder	Model SCHNEIDER RJ1772XB12 Category 6a FTP socket
Connexion Audio/Vidéo	DIN base		Audio connector	3-pin female base (male plug on request)
	Speaker		Speaker socket	Model LEGRAND 67311 - Terminal with push/release connectors
	Flush RCA socket		Audio/video connector	D-serie female base
	HDMI		HD audio/video connector	Female/female connector
TV Connection	TV-FM-SAT		TV, radio and satellite antennas socket	
	TV outlet		TV antenna socket	
IT-connection	USB power		USB A power socket	- Simple : Model LEGRAND 77591 - 5V/1100mA - Double : Model LEGRAND 67462 - 5V/2400mA
			USB C power socket	- Simple : Model LEGRAND 77589 - Double : Model LEGRAND 67466
			USB A+C power socket	Model NIKO 420-00513
Others	---		Shaver socket	Model VIMAR 16290 It can work with european, american, british and australian plugs
	---		Cable outlet	Specify diameter
	---		Cable lead-out	Specify diameter (12mm max)

BACK BOXES

All MELJAC products are fixed onto back boxes. Screws are supplied in same finish as plates.

MELJAC designs its own back boxes and continues to develop new series in line with its ranges.

Type of back box	Back box overview	Back box colour	Reference	Compatible with...	Overall dimensions (L. x W. x D. in mm)	Price
<p>Mixed MELJAC back boxes for CLASSIQUE, ELLIPSE, DAMIER, SOLARIS and PIERROT collections</p> <p>Mixed models are used in masonry and dry partition with an additional kit to maintain back box into the wall.</p>			CBBOICZ-Z080800299	Plates 80x80, 84x84 and Ø98 mm	71x69x50 Screws interaxis 60 mm	4,12
			CBBOICZ-Z115800199	Plates 115x80 and 120x84 mm	97x69x50 Screws interaxis 88 mm	4,43
			CBBOICZ-Z142800199	Plates 142x80 and 144x84 mm	128x69x50 Screws interaxis 117 mm	4,82
			CBBOICZ-Z205800199	Plates 205x80 and 210x84 mm	190x69x50 Screws interaxis 180 mm	6,02
			CBBOICZ-Z267800199	Plates 267x80 mm	252x69x50 Screws interaxis 242 mm	7,94
Kit for back box adaptation in DRY PARTITION		- - -	CBBOICZ-Z0MELKIT99	Plates 80x80, Ø98, 115x80, 142x80, 205x80 and 267x80 mm		1,59
Partition to separate the high and low currents	- - -	- - -	CBAENT-MEL50500099	Plates 142x80, 205x80 and 267x80 mm		0,71
<p>Narrow MELJAC back boxes for CLASSIQUE, ELLIPSE AND VOLUMES collections</p> <p>Designed for narrow plates, they may be used in masonry only and must be sealed.</p>			CBBOICZ-Z091380199	Plates 38x91 mm and doorbell 1920	76x37x45 Screws interaxis 66 mm	4,06
			CBBOICZ-Z133380199	Plates 38x133 mm	118x37x45 Screws interaxis 108 mm	4,19
			CBBOICZ-Z175380199	Plates 38x175 mm	160x37x45 Screws interaxis 150 mm	4,33















L : length

W : width

D : depth

Prices 03/23 in euros
without VAT

BACK BOXES

Type of back box	Back box overview	Back box colour	Reference	Compatible with...	Overall dimensions (L. x W. x D. in mm)	Price
<p>Back boxes for VOLUMES and CANNELÉE collections</p> <p>LEGRAND 80051, for dry partition only.</p> <p>LEGRAND 80052, for dry partition only.</p> <p>LEGRAND 89246, for masonry only, must be sealed.</p>			CBBBOIL-8005100099	Oval, hexagonal and octagonal plates, Skate, Palet Plates 80x80 of the Cannelée collection	Ø 67xP.50 mm	2,61
			CBBBOIL-8005200099	Plates 151x80 of the Cannelée collection	Ø 2x67 xP.50 mm	10,99
			CBBBOIL-8924600099	Plates Ø 56 mm and 56x56 mm, Macaroons, 1930, 1951, Dome, square and rectangular bell blocks	Ø 47xP.40 mm	7,75
<p>Water-resistant MELJAC back boxes with installation template for SOL collection</p> <p>To install the products with water-resistant cover, installation templates corresponding to the final dimensions of the plates are provided. They are mounted on back boxes for masonry only and must be sealed.</p> <p>The templates allow perfect placement of the back box so that the plate lies flush with the floor.</p>			CBBOISZ-Z10D100199 CBBOISZ-Z14D100199	Plates Ø 100x10 mm Plates Ø 100x14 mm	Ø 100x60 Ø 100x64	6,35
			CBBOISZ-Z10L100199 CBBOISZ-Z14L100199	Plates 100x100x10 mm Plates 100x100x14 mm	100x100x60 100x100x64	6,35
			CBBOISZ-Z10L180199 CBBOISZ-Z14L180199	Plates 180x100x10 mm Plates 180x100x14 mm	180x100x60 180x100x64	9,60
			CBBOISZ-Z10L180299 CBBOISZ-Z14L180299	Plates 180x200x10 mm Plates 180x200x14 mm	180x200x60 180x200x64	19,21

Renovation

Some models of CLASSIQUE and ELLIPSE collections are compatible with the existing standard back boxes (please contact us). MELJAC also proposes bespoke products for an installation on other back boxes.

Prices 03/23 in euros
without VAT

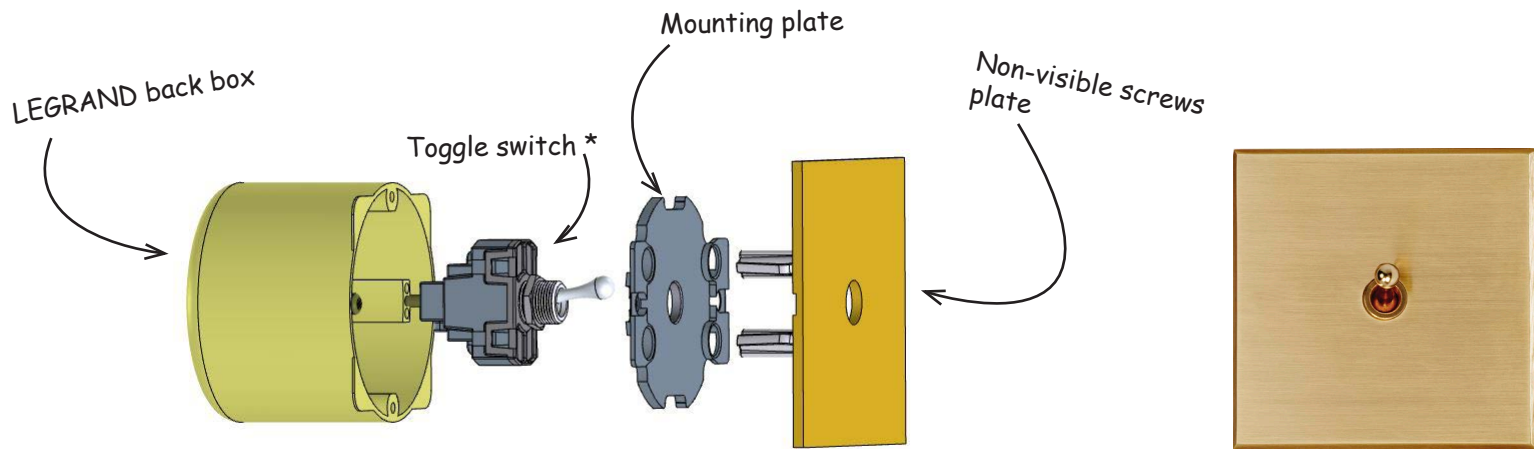
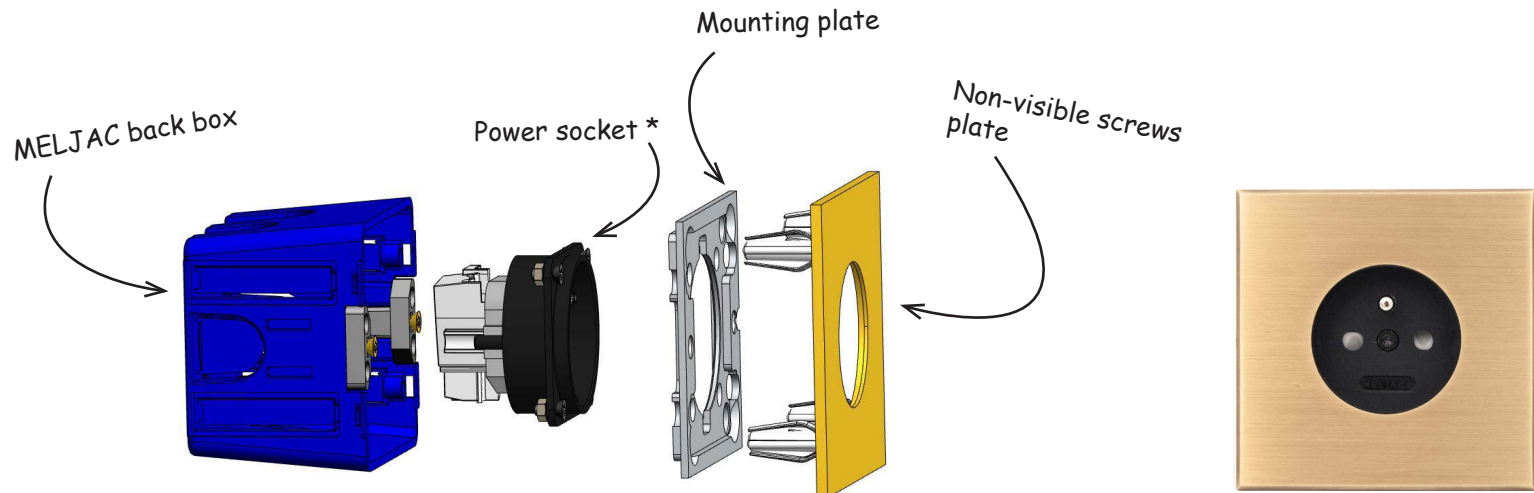

* Example (other mechanisms on demand)

NON-VISIBLE SCREWS OPTION

The screwless option adds a supplement corresponding to the price of the backplate that needs to be fixed to the back box.

This option is only available for the CLASSIQUE and ELLIPSE collections. It is not available for the other brass collections which are already screwless (DAMIER, ELLIOT, CANNELEE, SOL and VOLUMES) or for the collections made of other materials (PIERROT, PLEXIGLASS and LIMOGES).

Type of back box	Compatible with...	Reference	Cold finishes	Warm finishes	Special finishes
Mounting plates for MELJAC back boxes	Plates 80x80	AA3008Z-Z0001MOD	25,00	26,25	30,00
	Plates 80x115	AA3000Z-Z0001MOD	25,00	26,25	30,00
	Plates 80x142	AA3002Z-Z0001MOD	31,00	32,55	37,20
	Plates 205x80	AA3004Z-Z0003MOD	37,00	38,85	44,40
	Plates 267x80	AA3006Z-Z0004MOD	43,00	45,15	51,60
	Plates 38x91	- - -	25,00	26,25	30,00
	Plates 38x133	- - -	25,00	26,25	30,00
	Plates 38x175	- - -	31,00	32,55	37,20
Mounting plates for LEGRAND back boxes	Simple	AA3008Z-Z1001MOD	31,00	32,55	37,20
	Double	AA3025Z-Z0002MOD	41,00	43,05	49,20
	Triple	AA3031Z-Z0003MOD	51,00	53,55	61,20
	Quadruple	AA3038Z-Z0004MOD	61,00	64,05	73,20

*to be added to the price of the plate and back box

Prices 03/23 in euros
without VAT

TERMS & CONDITIONS OF SALE

I. MAIN CLAUSE

These General Terms and Conditions apply to all sales of our products, and prevail over any and all other terms and conditions of purchase, unless otherwise expressly agreed and signed in writing by ourselves.

They were updated on 1 October 2022, supersede the previous Terms and Conditions of a prior date and may be changed without prior notice.

II. CONFIDENTIALITY

All designs, plans, drawings or documents which are provided or sent by MELJAC remain the property of same; in any case and for any reason, they may not be disclosed to third parties, under penalty of damages.

III. CONTRACT FORMATION

An order may only be registered and give rise to a MELJAC purchase order if:

- (i) It occurs subsequent to the issuance of a quotation: it must be approved by returning it to the MELJAC sales department dated, signed and marked “good for agreement” (mandatory for private customers). Our quotations are valid for 2 months from date of issue.
- (ii) It is duly written in the form of a Purchase Order on letterhead for companies, with the name and signature of the requester.
- (iii) All items necessary for production have been supplied to the MELJAC sales department:
 - a. Feasibility and diagrams of engraving dated and signed with the words “good for agreement” appearing thereon
 - b. Equipment to be adorned in the case of an order for a plate as casing for equipment not supplied by MELJAC

Manufacturing lead times run only from the time when points (i), (ii) and (iii) are observed and the order is accepted by MELJAC.

This order implies acceptance of the prices in effect on the order date, and the terms of any rebate or trade discount granted.

For any order giving rise to a production order, **no change or cancellation** may be made **after 48 hours**. Within this time span we accept only 2 changes to the same order, which corresponds to one change every 24 hours.

After 48 hours of issuance of the initial order, no change or cancellation may be considered and a new quotation will need to be approved prior to conversion into a **new order**. This new order will naturally be reintegrated into the production priorities as of the new order date.

Similarly, no goods may be returned unless specifically agreed with the person in charge of the commercial offer.

IV. DELIVERY

Owing to the craftsmanship involved in manufacturing the order, the average lead times are provided for general guidance purposes only and may not constitute a binding contractual agreement: a minimum of between 6 and 8 weeks for standard equipment in certain collections (Classique collection); special equipment will be assessed on a case by case basis. Quotations provide an approximate shipping date in weeks and this date may be confirmed or reviewed when the purchase order is sent.

We use our best endeavours to meet the shipping dates indicated. Any delays do not entitle the buyer to cancel the sale, refuse the goods, or claim damages. In any event, we may not be held liable:

- (i) If the payment terms specified are not adhered to
- (ii) If information necessary for the execution of orders is not provided to us in good time
- (iii) In the event of a delay by our own suppliers, unforeseen events, etc.

In such conditions, no penalty for late shipment may be accepted by MELJAC, except in specific cases and subject to prior written agreement.

TERMS & CONDITIONS OF SALE

V. RETENTION OF TITLE

MELJAC retains ownership of goods sold until effective payment of the full price in principal and accessories.

Failure to pay any one of the instalments may lead to repossession of the goods concerned by MELJAC. After 6 months from order execution and the first reminder to pay the remaining balance on the order, MELJAC shall proceed with order cancellation, reintegration (where possible) of the products/components to stocks and shall retain the deposit already paid by way of compensation.

VI. PRICES – TERMS OF PAYMENT

The prices set by MELJAC are exclusive of VAT and in euro; their term of validity is clearly indicated.

Shipping fees are not included in the price (prices are quoted EXW (ICC INCOTERMS 2000): Ex Works).

MELJAC reserves the right to amend them without notice at any time, in particular due to raw material price fluctuation.

An initial minimum payment of 30% of the full order price will apply for all firm orders placed. Payment will be 100% of the full order price in the case of orders equal to or under 500 euro including VAT.

Payment of the remaining balance shall be made before order shipment or collection, according to the shipping terms specified on order confirmation.

Any other payment terms shall be mentioned beforehand on a contractual document issued by MELJAC and signed by the client. In the event of any change to the legal or financial situation of the client, we reserve the right, even after partial execution of the order, to require guarantees to continue its execution.

The terms of payment shall be endorsed and accepted when the order is placed, including payment of the deposit, under penalty of delaying order registration.

Any delay in the settlement of a previous order may halt any new order or suspend any existing order until complete settlement of the requester's account, without prejudice to any other course of action.

In the event of postponed shipment through the client's fault, storage charges may be invoiced.

VII. GUARANTEE

MELJAC's guarantee covers its products against any defect in design, material and/or workmanship for a period of 24 months under the following conditions:

- Any apparent defect must imperatively be reported to MELJAC upon receipt of the goods;
- Any malfunction must be revealed or be reported to MELJAC within a maximum period of 7 days as from shipment, it being specified that the product must be used in accordance with its intended purpose and nature.

Upon expiry of the above periods, the buyer shall no longer be entitled to enforce the guarantee. This period of 24 months runs from the shipment date.

The client shall be required to inform MELJAC by providing explanations about the defect encountered, illustrated with photos. MELJAC may, if necessary, request that the product in question be returned to its premises for inspection.

It is understood that the above guarantee is excluded in the following cases:

- (i) in the event of installation that does not comply with professional standards and practices or the technical instructions (where such instructions exist), and in the event of abnormal, improper or inappropriate use of the product given its nature and/or contractual purpose;
- (ii) in the event, after shipment, of lack of/defective storage and/or misstorage, maintenance, conservation or custody required by the nature and/or contractual purpose of the product, in particular climatic conditions, hydrometric conditions, temperature, light, poorly protected warehouse (this list is not limitative).

The client also acknowledges being informed that surface treatments are likely to change over time according to the conditions referred to in subparagraph (ii) above. **Such potential changes are not guaranteed.**

TERMS & CONDITIONS OF SALE

MELJAC's liability is expressly limited to the guarantees and reservations defined above and may under no circumstances be sought or engaged due to incidents and/or accidents caused to people or items in the event of abnormal installation and/or use or installation or use that is ill-suited to the purpose or nature of our products. Our liability is in any event financially limited to the amount (VAT excluded) of the product(s) or materials under investigation.

The above contractual guarantee shall in no way be construed as limiting the French legal guarantees.

VIII. RESOLUTIVE CLAUSE

In the event of non-execution of their obligations by either party, the contract governed by these General Terms and Conditions of Sale shall be terminated ipso jure to the benefit of the other party, without prejudice or damages that might be claimed by the defaulting party.

Termination shall take effect 15 days after written notice thereof has been sent by registered post with acknowledgement of receipt and remains unsuccessful.

IX. ATTRIBUTION OF JURISDICTION

Any dispute regarding the conclusion, execution or interpretation of the contract and sales which could not be resolved amicably shall be referred to the exclusive jurisdiction of the Commercial Court of Paris, which is expressly granted jurisdiction.

X. ACCEPTANCE AND OBJECTION

The present General Terms and Conditions of Sale constitute an element of contract.

MELJAC clients shall be deemed to have accepted such Terms and Conditions unless reservations are made at the time of the order.



Showroom & Headquarter

3 rue de la Procession
75015 PARIS
FRANCE

☎ : +33 (0)1 40 61 08 43
📠 : +33 (0)1 40 61 08 46
✉ : france@meljac.com

Showroom Rhone-Alpes Region

5 rue Charles DULLIN
69002 LYON
FRANCE

☎ : +33 (0)4 78 38 37 72
📠 : +33 (0)4 78 38 09 64
✉ : lyon@meljac.com

Export Department

☎ : +33 (0)1 47 34 21 42
📠 : +33 (0)1 47 34 21 46
✉ : export@meljac.com

Other services

☎ : +33 (0)1 70 08 06 30
✉ : yachting@meljac.com
✉ : hospitality@meljac.com

Distributed by:

www.meljac.com



@maisonmeljac